

This tender floated in GeM portal. Bidder has to submit their offer through GeM only.

बिड दस्तावेज़ / Bid Document

बिड विवरण / Bid Details	
बिड बंद होने की तारीख/समय / Bid End Date/Time	04-07-2026 13:00:00
बिड खुलने की तारीख/समय / Bid Opening Date/Time	04-07-2026 13:30:00
बिड पेशकश वैधता (बंद होने की तारीख से) / Bid Offer Validity (From End Date)	90 (Days)
मंत्रालय/राज्य का नाम / Ministry/State Name	Pmo
विभाग का नाम / Department Name	Department Of Atomic Energy
संगठन का नाम / Organisation Name	Irel (india) Limited
कार्यालय का नाम / Office Name	Ho
शिकायत निवारण के संपर्क विवरण / Contact details of Grievance redressal	purchase-red@irel.co.in
कुल मात्रा / Total Quantity	3700
वस्तु श्रेणी / Item Category	Title 1 , Title 2 , Title 3 , Title 4 , Title 5 , Title 6 , Title 7
GeMARPTS में खोजी गई स्ट्रिंग्स / Searched Strings used in GeMARPTS	Procurement of Jumbo Bag
GeMARPTS में खोजा गया परिणाम / Searched Result generated in GeMARPTS	Flexible Intermediate Bulk Containers Bag / Jumbo Bag, Urine Collection Bag - Sterile (Single Use), Pouches & Toiletries Bag-Handicraft (Bamboo), High standard Limestone(KIOSL), Office Bags (V2), Polyethylene Bags for General Purposes, Bag Calico- OFB, Parcel Bag Labels of 'CBD / CED' Series, Poly-pallets for bag storage godowns (V2) Conforming to IS 13664, Tool kit for Home Decorative Items - Baghpat - under ODOP Scheme of Govt. of Uttar Pradesh
अधिसूचना के लिए चयनित प्रासंगिक श्रेणियाँ / Relevant Categories selected for notification	<ul style="list-style-type: none"> Flexible Intermediate Bulk Containers Bag / Jumbo Bag
बीओक्यू शीर्षक / BOQ Title	Jumbo bag with liner and discharge spout
बिडर का न्यूनतम औसत वार्षिक टर्नओवर (3 वर्षों का) / Minimum Average Annual Turnover of the bidder (For 3 Years)	11 Lakh (s)
उन्हीं/समान सेवा के लिए अपेक्षित विगत अनुभव के वर्ष / Years of Past Experience Required for same/similar service	3 Year (s)

बिड विवरण/Bid Details	
वर्षों के अनुभव एवं टर्नओवर से एमएसई को छूट प्राप्त है / MSE Relaxation for Years Of Experience and Turnover	Yes Complete
स्टार्टअप के लिए अनुभव के वर्षों और टर्नओवर से छूट प्रदान की गई है / Startup Relaxation for Years Of Experience and Turnover	Yes Complete
विक्रेता से मांगे गए दस्तावेज़/ Document required from seller	Experience Criteria,Bidder Turnover,Certificate (Requested in ATC),Additional Doc 1 (Requested in ATC),Additional Doc 2 (Requested in ATC) *In case any bidder is seeking exemption from Experience / Turnover Criteria, the supporting documents to prove his eligibility for exemption must be uploaded for evaluation by the buyer
क्या आप निविदाकारों द्वारा अपलोड किए गए दस्तावेज़ों को निविदा में भाग लेने वाले सभी निविदाकारों को दिखाना चाहते हैं? संदर्भ मेन् है/ Do you want to show documents uploaded by bidders to all bidders participated in bid?	No
बिड लगाने की समय सीमा स्वतः नहीं बढ़ाने के लिए आवश्यक बिड की संख्या। / Minimum number of bids required to disable automatic bid extension	2
दिनों की संख्या, जिनके लिए बिड लगाने की समय-सीमा बढ़ाई जाएगी। / Number of days for which Bid would be auto-extended	5
ऑटो एक्सटेंशन अधिकतम कितनी बार किया जाना है। / Number of Auto Extension count	1
बिड से रिवर्स नीलामी सक्रिय किया/ Bid to RA enabled	No
क्रेता के लिए उपलब्ध आईटीसी/ITC available to buyer	Yes
बिड का प्रकार/ Type of Bid	Two Packet Bid
प्राथमिक उत्पाद श्रेणी/ Primary product category	Title 1
तकनीकी मूल्यांकन के दौरान तकनीकी स्पष्टीकरण हेतु अनुमत समय / Time allowed for Technical Clarifications during technical evaluation	2 Days
निरीक्षण आवश्यक (सूचीबद्ध निरीक्षण प्राधिकरण /जेम के साथ पूर्व पंजीकृत एजेंसियों द्वारा)/ Inspection Required (By Empanelled Inspection Authority / Agencies pre-registered with GeM)	No
अनुमानित बिड मूल्य / Estimated Bid Value	4399130
Payment Timelines	Payments shall be made to the Seller within 30 days of issue of consignee receipt-cum-acceptance certificate (CRAC) and on-line submission of bills (This is in supersession of 10 days time as provided in clause 12 of GeM GTC)

बिड विवरण/Bid Details

मूल्यांकन पद्धति/Evaluation Method	Total value wise evaluation
वित्तीय दस्तावेज की आवश्यकता है / Financial Document Required	Yes
मध्यस्थता खंड/Arbitration Clause	No
सुलह खंड/Mediation Clause	No

ईएमडी विवरण/EMD Detail

एडवाइजरी बैंक/Advisory Bank	State Bank of India
ईएमडी राशि/EMD Amount	74562

ईपीबीजी विवरण /ePBG Detail

एडवाइजरी बैंक/Advisory Bank	State Bank of India
ईपीबीजी प्रतिशत (%) /ePBG Percentage(%)	5.00
ईपीबीजी की आवश्यक अवधि (माह) /Duration of ePBG required (Months).	10

(a). जेम की शर्तों के अनुसार ईएमडी छूट के इच्छुक बिडर को संबंधित केटेगरी के लिए बिड के साथ वैध समर्थित दस्तावेज प्रस्तुत करने है। एमएसई केटेगरी के अंतर्गत केवल वस्तुओं के लिए विनिर्माता तथा सेवाओं के लिए सेवा प्रदाता ईएमडी से छूट के पात्र हैं। व्यापारियों को इस नीति के दायरे से बाहर रखा गया है।/EMD EXEMPTION: The bidder seeking EMD exemption, must submit the valid supporting document for the relevant category as per GeM GTC with the bid. Under MSE category, only manufacturers for goods and Service Providers for Services are eligible for exemption from EMD. Traders are excluded from the purview of this Policy.

(b).ईएमडी और संपादन जमानत राशि, जहां यह लागू होती है, लाभार्थी के पक्ष में होनी चाहिए। / EMD & Performance security should be in favour of Beneficiary, wherever it is applicable.

(c).ईएमडी और संपादन जमानत राशि लाभार्थी के पक्ष में होनी चाहिए। / Earnest Money Deposit (EMD) shall also be accepted by the buyer in the form of a surety bond.

लाभार्थी /Beneficiary :

DGM-Finance
IREL (India) Limited,RED, Udyogamandal
(Shri. Gautham Samui)

बोली विभाजन लागू नहीं किया गया/ Bid splitting not applied.

एमआईआई खरीद वरीयता / MII Purchase Preference

एमआईआई खरीद वरीयता / MII Purchase Preference	Yes
--	-----

मेक इन इंडिया विक्रेताओं को खरीद में प्राथमिकता, यदि उनका मूल्य L1+X% तक की सीमा में है / Purchase Preference to MII sellers available upto price within L1+X%	20
मेक इन इंडिया खरीद में प्राथमिकता के लिए बिड की मात्रा का अधिकतम प्रतिशत / Maximum Percentage of Bid quantity for MII purchase preference	50
सार्वजनिक खरीद (मेक-इन-इंडिया को प्राथमिकता) आदेश 2017 के अनुसार केवल क्लास 1/क्लास 2 के स्थानीय आपूर्तिकर्ताओं को ही भागीदारी की अनुमति है दिनांक 16.09.2020 (समय-समय पर संशोधित एवं लागू) / Allow participation only from Class 1/Class 2 local suppliers as per the Public procurement(Preference to Make-in-india) order 2017 date 16.09.2020(as amended and applicable time to time)	Yes, in compliance with the MII ORDER : DPIIT Order(as amended and applicable time to time)

एमएसई खरीद वरीयता/MSE Purchase Preference

एमएसई खरीद वरीयता/MSE Purchase Preference	Yes
सूक्ष्म और लघु उद्यम मूल उपकरण निर्माताओं/सेवा प्रदाता को खरीद में प्राथमिकता, यदि उनका मूल्य L1+X% / Purchase Preference to MSE OEMs/ Service Provider available upto price within L1+X%	15
सूक्ष्म और लघु उद्यम मूल उपकरण निर्माता/सेवा प्रदाता को खरीद में प्राथमिकता के लिए बिड की मात्रा का अधिकतम प्रतिशत / Percentage of Bid quantity/amount for MSE OEMs/ Service Provider Purchase preference	25

ट्रेड्स भुगतान संबंधी विवरण/TReDS Payment Details

This Bid provides for Trade Receivables Discounting System (TReDS) as Preferred mode of payment. For MSME sellers, payments may be processed through a TReDS exchange in which the Buyer is registered, subject to applicable policy and regulatory guidelines. Accordingly, sellers intending to avail payment through TReDS are required to be registered with at least one TReDS exchange in which the buyer is registered.

1. If the bidder is a Micro or Small Enterprise as per latest orders issued by Ministry of MSME, the bidder shall be relaxed from the eligibility criteria of "Experience Criteria" as defined above subject to meeting of quality and technical specifications. The bidder seeking Relaxation from Experience Criteria, shall upload the supporting documents to prove his eligibility for Relaxation.
2. If the bidder is a Micro or Small Enterprise (MSE) as per latest orders issued by Ministry of MSME, the bidder shall be relaxed from the eligibility criteria of "Bidder Turnover" as defined above subject to meeting of quality and technical specifications. If the bidder itself is MSE OEM of the offered products, it would be relaxed from the "OEM Average Turnover" criteria also subject to meeting of quality and technical specifications. The bidder seeking Relaxation from Turnover, shall upload the supporting documents to prove his eligibility for Relaxation.
3. If the bidder is a DPIIT registered Startup, the bidder shall be relaxed from the the eligibility criteria of "Experience Criteria" as defined above subject to their meeting of quality and technical specifications. The bidder seeking Relaxation from Experience Criteria, shall upload the supporting documents to prove his eligibility for Relaxation.
4. If the bidder is a DPIIT registered Startup, the bidder shall be relaxed from the the eligibility criteria of "Bidder

Turnover" as defined above subject to their meeting of quality and technical specifications. If the bidder is DPIIT Registered OEM of the offered products, it would be relaxed from the "OEM Average Turnover" criteria also subject to meeting of quality and technical specifications. The bidder seeking Relaxation from Turnover shall upload the supporting documents to prove his eligibility for Relaxation.

5. The minimum average annual financial turnover of the bidder during the last three years, ending on 31st March of the previous financial year, should be as indicated above in the bid document. Documentary evidence in the form of certified Audited Balance Sheets of relevant periods or a certificate from the Chartered Accountant / Cost Accountant indicating the turnover details for the relevant period shall be uploaded with the bid. In case the date of constitution / incorporation of the bidder is less than 3-year-old, the average turnover in respect of the completed financial years after the date of constitution shall be taken into account for this criteria.

6. Experience Criteria: In respect of the filter applied for experience criteria, the Bidder or its OEM of the product offered in the bid {themselves or through reseller(s)} should have regularly, manufactured and supplied same or similar Category Products to any Central / State Govt Organization / PSU for number of Financial years as indicated above in the bid document before the bid opening date. Copies of relevant contracts and delivery acceptance certificates like CRAC to be submitted along with bid in support of having supplied some quantity during each of the Financial year. In case of bunch bids, the category of primary product having highest value should meet this criterion.

7. Preference to Make In India products (For bids < 200 Crore): Preference shall be given to Class 1 local supplier as defined in public procurement (Preference to Make in India), Order 2017 as amended from time to time and its subsequent Orders/Notifications issued by concerned Nodal Ministry for specific Goods/Products. The minimum local content to qualify as a Class 1 local supplier is denoted in the bid document. If the bidder wants to avail the Purchase preference, the bidder must upload a certificate from the OEM regarding the percentage of the local content and the details of locations at which the local value addition is made along with their bid, failing which no purchase preference shall be granted. In case the bid value is more than Rs 10 Crore, the declaration relating to percentage of local content shall be certified by the statutory auditor or cost auditor, if the OEM is a company and by a practicing cost accountant or a chartered accountant for OEMs other than companies as per the Public Procurement (preference to Make-in -India) order 2017 dated 04.06.2020. Only Class-I and Class-II Local suppliers as per MII order dated 4.6.2020 will be eligible to bid. Non - Local suppliers as per MII order dated 04.06.2020 are not eligible to participate. However, eligible micro and small enterprises will be allowed to participate .The buyers are advised to refer the OM No.F.1/4/2021-PPD dated 18.05.2023.

[OM No.1 4 2021 PPD dated 18.05.2023](#) for compliance of Concurrent application of Public Procurement Policy for Micro and Small Enterprises Order, 2012 and Public Procurement (Preference to Make in India) Order, 2017 and its subsequent Orders/Notifications issued by concerned Ministry .Benefits of MSE will be allowed only if seller/service provider is validated on-line in GeM profile as well as validated and approved by Buyer after evaluation of documents submitted.

8. Purchase preference to Micro and Small Enterprises (MSEs): Purchase preference will be given to MSEs having valid Udyam Certificate and whose credentials are validated online through Udyam Registration portal as defined in Public Procurement Policy for Micro and Small Enterprises (MSEs) Order, 2012 dated 23.03.2012 issued by Ministry of Micro, Small and Medium Enterprises and its subsequent Orders/Notifications issued by concerned Ministry. If the bidder wants to avail themselves of the Purchase preference, the bidder must be the manufacturer / OEM of the offered product on GeM. In respect of bid for Services, the bidder must be the Service provider of the offered Service. Traders are excluded from the purview of Public Procurement Policy for Micro and Small Enterprises and hence resellers offering products manufactured by some other OEM are not eligible for any purchase preference. Relevant documentary evidence in this regard shall be uploaded along with the bid in respect of the offered product or service, and Buyer will decide eligibility for purchase preference based on documentary evidence submitted in case of product bids, whereas in case of services the eligibility is automatically validated. If L-1 is not an MSE and MSE Seller (s) has / have quoted price within L-1+ 15% (Selected by Buyer) of margin of purchase preference /price band defined in relevant policy, such MSE Seller shall be given opportunity to match L-1 price and contract will be awarded for 25% (selected by Buyer) percentage of total quantity. The buyers are advised to refer the [OM No.1 4 2021 PPD dated 18.05.2023](#) for compliance of Concurrent application of Public Procurement Policy for Micro and Small Enterprises Order, 2012 and Public Procurement (Preference to Make in India) Order, 2017. Benefits of MSE will be allowed only if seller is validated on-line in GeM profile as well as validated and approved by Buyer after evaluation of documents submitted.

9. Estimated Bid Value indicated above is being declared solely for the purpose of guidance on EMD amount and for determining the Eligibility Criteria related to Turn Over, Past Performance and Project / Past Experience etc. This has no relevance or bearing on the price to be quoted by the bidders and is also not going to have any impact on bid participation. Also this is not going to be used as a criteria in determining reasonableness of quoted prices which would be determined by the buyer based on its own assessment of reasonableness and based on competitive prices received in Bid / RA process.

If the buyer has mentioned MSE purchase preference in ATC then service provider is required to upload necessary documents for MSE purchase preference for verification by the buyer during evaluation.

Title 1

(क्रमशः श्रेणी 1 और श्रेणी 2 के स्थानीय आपूर्तिकर्ता के रूप में अर्हता प्राप्त करने के लिए आवश्यक/Minimum 50% and 20% Local Content required for qualifying as Class 1 and Class 2 Local Supplier respectively)

तकनीकी विशिष्टियाँ /Technical Specifications

Specification Document	View File
BOQ Detail Document	View File

Advisory-Please refer attached BOQ document for detailed consignee list and delivery period.

इनपुट कर क्रेडिट(आईटीसी) तथा रिवर्स प्रभार (आरसीएम)/Input Tax Credit(ITC) and Reverse Charge(RCM) Details

जीएसटी पर इनपुट कर क्रेडिट /ITC on GST	जीएसटी उपकर कर क्रेडिट /ITC on GST Cess
100%	100%

परेषिती/रिपोर्टिंग अधिकारी तथा मात्रा/Consignees/Reporting Officer and Quantity

क्र.सं./S.N o.	परेषिती/रिपोर्टिंग अधिकारी /Consignee Reporting/Officer	पता/Address	मात्रा /Quantity	डिलीवरी के दिन/Delivery Days
1	Anil Kumar.V.A	683501,IREL (India) Limited; UDYOGMANDAL,Ernakulam.	1000	270

Title 2

(क्रमशः श्रेणी 1 और श्रेणी 2 के स्थानीय आपूर्तिकर्ता के रूप में अर्हता प्राप्त करने के लिए आवश्यक/Minimum 50% and 20% Local Content required for qualifying as Class 1 and Class 2 Local Supplier respectively)

तकनीकी विशिष्टियाँ /Technical Specifications

Specification Document	View File
BOQ Detail Document	View File

Advisory-Please refer attached BOQ document for detailed consignee list and delivery period.

इनपुट कर क्रेडिट(आईटीसी) तथा रिवर्स प्रभार (आरसीएम)/Input Tax Credit(ITC) and Reverse Charge(RCM) Details

जीएसटी पर इनपुट कर क्रेडिट /ITC on GST	जीएसटी उपकर कर क्रेडिट /ITC on GST Cess
100%	100%

परेषिती/रिपोर्टिंग अधिकारी तथा मात्रा/Consignees/Reporting Officer and Quantity

क्र.सं./S.N o.	परेषिती/रिपोर्टिंग अधिकारी /Consignee Reporting/Officer	पता/Address	मात्रा /Quantity	डिलीवरी के दिन/Delivery Days
1	Anil Kumar.V.A	683501,IREL (India) Limited; UDYOGMANDAL,Ernakulam.	950	270

Title 3

(क्रमशः श्रेणी 1 और श्रेणी 2 के स्थानीय आपूर्तिकर्ता के रूप में अर्हता प्राप्त करने के लिए आवश्यक/Minimum 50% and 20% Local Content required for qualifying as Class 1 and Class 2 Local Supplier respectively)

तकनीकी विशिष्टियाँ /Technical Specifications

Specification Document	View File
BOQ Detail Document	View File

Advisory-Please refer attached BOQ document for detailed consignee list and delivery period.

इनपुट कर क्रेडिट(आईटीसी) तथा रिवर्स प्रभार (आरसीएम)/Input Tax Credit(ITC) and Reverse Charge(RCM) Details

जीएसटी पर इनपुट कर क्रेडिट /ITC on GST	जीएसटी उपकर कर क्रेडिट /ITC on GST Cess
100%	100%

परेषिती/रिपोर्टिंग अधिकारी तथा मात्रा/Consignees/Reporting Officer and Quantity

क्र.सं./S.N o.	परेषिती/रिपोर्टिंग अधिकारी /Consignee Reporting/Officer	पता/Address	मात्रा /Quantity	डिलीवरी के दिन/Delivery Days
1	Anil Kumar.V.A	683501,IREL (India) Limited; UDYOGMANDAL,Ernakulam.	500	270

Title 4

(क्रमशः श्रेणी 1 और श्रेणी 2 के स्थानीय आपूर्तिकर्ता के रूप में अर्हता प्राप्त करने के लिए आवश्यक/Minimum 50% and 20% Local Content required for qualifying as Class 1 and Class 2 Local Supplier respectively)

तकनीकी विशिष्टियाँ /Technical Specifications

Specification Document	View File
BOQ Detail Document	View File

Advisory-Please refer attached BOQ document for detailed consignee list and delivery period.

इनपुट कर क्रेडिट(आईटीसी) तथा रिवर्स प्रभार (आरसीएम)/Input Tax Credit(ITC) and Reverse Charge(RCM) Details

जीएसटी पर इनपुट कर क्रेडिट /ITC on GST	जीएसटी उपकर कर क्रेडिट /ITC on GST Cess
100%	100%

परेषिती/रिपोर्टिंग अधिकारी तथा मात्रा/Consignees/Reporting Officer and Quantity

क्र.सं./S.N o.	परेषिती/रिपोर्टिंग अधिकारी /Consignee Reporting/Officer	पता/Address	मात्रा /Quantity	डिलीवरी के दिन/Delivery Days
1	Anil Kumar.V.A	683501,IREL (India) Limited; UDYOGMANDAL,Ernakulam.	25	270

Title 5

(क्रमशः श्रेणी 1 और श्रेणी 2 के स्थानीय आपूर्तिकर्ता के रूप में अर्हता प्राप्त करने के लिए आवश्यक/Minimum 50% and 20% Local Content required for qualifying as Class 1 and Class 2 Local Supplier respectively)

तकनीकी विशिष्टियाँ /Technical Specifications

Specification Document	View File
BOQ Detail Document	View File

Advisory-Please refer attached BOQ document for detailed consignee list and delivery period.

इनपुट कर क्रेडिट(आईटीसी) तथा रिवर्स प्रभार (आरसीएम)/Input Tax Credit(ITC) and Reverse Charge(RCM) Details

जीएसटी पर इनपुट कर क्रेडिट /ITC on GST	जीएसटी उपकर कर क्रेडिट /ITC on GST Cess
100%	100%

परेषिती/रिपोर्टिंग अधिकारी तथा मात्रा/Consignees/Reporting Officer and Quantity

क्र.सं./S.N o.	परेषिती/रिपोर्टिंग अधिकारी /Consignee Reporting/Officer	पता/Address	मात्रा /Quantity	डिलीवरी के दिन/Delivery Days
1	Anil Kumar.V.A	683501,IREL (India) Limited; UDYOGMANDAL,Ernakulam.	25	270

Title 6

(क्रमशः श्रेणी 1 और श्रेणी 2 के स्थानीय आपूर्तिकर्ता के रूप में अर्हता प्राप्त करने के लिए आवश्यक/Minimum 50% and 20% Local Content required for qualifying as Class 1 and Class 2 Local Supplier respectively)

तकनीकी विशिष्टियाँ /Technical Specifications

Specification Document	View File
BOQ Detail Document	View File

Advisory-Please refer attached BOQ document for detailed consignee list and delivery period.

इनपुट कर क्रेडिट(आईटीसी) तथा रिवर्स प्रभार (आरसीएम)/Input Tax Credit(ITC) and Reverse Charge(RCM) Details

जीएसटी पर इनपुट कर क्रेडिट /ITC on GST	जीएसटी उपकर कर क्रेडिट /ITC on GST Cess
100%	100%

परेषिती/रिपोर्टिंग अधिकारी तथा मात्रा/Consignees/Reporting Officer and Quantity

क्र.सं./S.N o.	परेषिती/रिपोर्टिंग अधिकारी /Consignee Reporting/Officer	पता/Address	मात्रा /Quantity	डिलीवरी के दिन/Delivery Days
1	Anil Kumar.V.A	683501,IREL (India) Limited; UDYOGMANDAL,Ernakulam.	700	270

Title 7

(क्रमशः श्रेणी 1 और श्रेणी 2 के स्थानीय आपूर्तिकर्ता के रूप में अर्हता प्राप्त करने के लिए आवश्यक/Minimum 50% and 20% Local Content required for qualifying as Class 1 and Class 2 Local Supplier respectively)

तकनीकी विशिष्टियाँ /Technical Specifications

Specification Document	View File
BOQ Detail Document	View File

Advisory-Please refer attached BOQ document for detailed consignee list and delivery period.

इनपुट कर क्रेडिट(आईटीसी) तथा रिवर्स प्रभार (आरसीएम)/Input Tax Credit(ITC) and Reverse Charge(RCM) Details

जीएसटी पर इनपुट कर क्रेडिट /ITC on GST	जीएसटी उपकर कर क्रेडिट /ITC on GST Cess
100%	100%

परेषिती/रिपोर्टिंग अधिकारी तथा मात्रा/Consignees/Reporting Officer and Quantity

क्र.सं./S.N o.	परेषिती/रिपोर्टिंग अधिकारी /Consignee Reporting/Officer	पता/Address	मात्रा /Quantity	डिलीवरी के दिन/Delivery Days
1	Anil Kumar.V.A	683501,IREL (India) Limited; UDYOGMANDAL,Ernakulam.	500	270

क्रेता द्वारा जोड़ी गई बिड की विशेष शर्तें/Buyer Added Bid Specific Terms and Conditions

1. Generic

OPTION CLAUSE: The Purchaser reserves the right to increase or decrease the quantity to be ordered up to 25 percent of bid quantity at the time of placement of contract. The purchaser also reserves the right to increase the ordered quantity up to 25% of the contracted quantity during the currency of the contract at the contracted rates. The delivery period of quantity shall commence from the last date of original delivery order and in cases where option clause is exercised during the extended delivery period the additional time shall commence from the last date of extended delivery period. The additional delivery time shall be $(\text{Increased quantity} \div \text{Original quantity}) \times \text{Original delivery period (in days)}$, subject to minimum of 30 days. If the original delivery period is less than 30 days, the additional time equals the original delivery period. The Purchaser may extend this calculated delivery duration up to the original delivery period while exercising the option clause. Bidders must comply with these terms.

2. Generic

Bidder shall submit the following documents along with their bid for Vendor Code Creation:

- Copy of PAN Card.
- Copy of GSTIN.
- Copy of Cancelled Cheque.
- Copy of EFT Mandate duly certified by Bank.

अस्वीकरण/Disclaimer

The Additional Terms and Conditions (ATC) have been incorporated by the Buyer after approval of their Competent Authority. The Buyer ,is solely responsible for the impact of these clauses on the bidding process, its outcome, and consequences thereof including any restriction arising in the bidding process due to these ATCs and including the modification of technical specifications and / or terms and conditions governing the bid.All

representations / grievances pertaining to the ATC clauses shall be raised with the buyer organization directly and not with GeM. If any of the clause(s) is/are incorporated by the Buyer regarding the following, the bid & resultant contract shall be treated as null & void. Further, GeM reserves the right, at its sole discretion, to cancel the bid forthwith, without issuance of any prior notice or intimation :-

1. Publishing Custom / BOQ bids for items for which regular GeM categories are available (unless such Custom / BOQ item is bunched with the major regular product Category Item).
2. Mandating procurement of / from specific Brand / Make / Model / Manufacturer / Dealer except in case of Single Bid / Proprietary Article Certificate (PAC) Buying.
3. Inclusion of disqualification criteria related to suspension of seller / service provider, where such suspension period has already expired.
4. Mandating submission of documents in physical form as a pre-requisite to qualify bidders.
5. Publishing bids on GeM for procurement of works.
6. Procurement of Goods by creating a Service bid on GeM & vice-versa.
7. Seeking sample with bid or approval of samples during bid evaluation process. However, trial / sample, as the case may be, shall be permitted in cases where trial / sample are allowed as per approved and published procurement policy of the Buyers' controlling Ministry / Department / State / Public Sector Enterprises Headquarters. If there is any violation of trial / sample clause with regard to approved policy of the Buyers' Ministry / Department / State / Public Sector Enterprises Headquarters, then this is to be determined and redressed by the concerned Buyer Organisation only.
8. Seeking experience from specific organization / department / institute only or from foreign / export experience.
9. Creating bid for items from incorrect categories.
10. Reference of conditions published on any external site or reference to external documents/clauses.
11. Asking for any Tender fee / Bid Participation fee, as the case may be.
12. Buyer added ATC Clauses which are in contravention of clauses defined in bid detail section, including specifications, EMD Detail, ePBG Detail and MII and MSE Purchase Preference sections of the bid, unless otherwise allowed by the applicable GeM GTC.
13. Any ATC clause in contravention with GeM GTC Clause 4 (xiii) (h) will be invalid. In case of multiple L1 bidders against a service bid, the buyer shall place the Contract by selection of a bidder amongst the L-1 bidders through a Random Algorithm executed by GeM system.
14. In a category based bid, adding additional items, through buyer added, additional scope of work/ additional terms and conditions/or any other document. If buyer needs more items along with the main item, the same must be added through bunching category based items or by bunching custom catalogues or bunching a BoQ with the main category based item, the same must not be done through ATC or Scope of Work.

Further, if any seller has any objection/grievance against these additional clauses or otherwise on any aspect of this bid, they can raise their representation against the same by using the Representation window provided in the bid details field in Seller dashboard after logging in as a seller. Buyer is duty bound to reply to all such representations and would not be allowed to open bids if he fails to reply to such representations.

All GeM Sellers/Service Providers shall ensure full compliance with all applicable labour laws, including the provisions, rules, schemes and guidelines under the four Labour Codes i.e. the Code on Wages, 2019; the Industrial Relations Code, 2020; the Occupational Safety, Health and Working Conditions Code, 2020; and the Code on Social Security, 2020 as and when notified and brought into force by the Government of India.

For all provisions of the Labour Codes that are pending operationalisation through rules, schemes or notifications, the corresponding provisions of the pre-existing labour enactments (such as The Minimum Wages Act, 1948, The Payment of Wages Act, 1936, The Payment of Bonus Act, 1965, The Equal Remuneration Act, 1976, The Payment of Gratuity Act, 1972, etc. and relevant State Rules) shall continue to remain applicable.

The Seller/ Service Providers shall, therefore, be responsible for ensuring compliance under:

- **All notified and enforceable provisions of the new Labour Codes as mentioned hereinabove; and**
- **All operative provisions of the erstwhile Labour Laws until their complete substitution.**

All obligations relating to wages, social security, safety, working conditions, industrial relations etc. and any other statutory requirements shall be strictly met by the Seller/ Service Provider. Any non-compliance shall constitute a breach of the contract and shall entitle the Buyer to take appropriate action in accordance with the contract and applicable law.

This Bid is governed by the General Terms and Conditions, conditions stipulated in Bid and Service Level Agreement specific to the Service, as the case may be, as provided in the Marketplace.

However, in case of Service, if any condition specified in General Terms and Conditions is contradicted by the conditions stipulated in Service Level Agreement specific to said Service, then it will over-ride the conditions in the General Terms and Conditions.

[यह बिड सामान्य शर्तों के अंतर्गत भी शासित है /This Bid is also governed by the General Terms and Conditions.](#)

जेम की सामान्य शर्तों के खंड 26 के संदर्भ में भारत के साथ भूमि सीमा साझा करने वाले देश के बिडर से खरीद पर प्रतिबंध के संबंध में भारत के साथ भूमि सीमा साझा करने वाले देश का कोई भी बिडर इस निविदा में बिड देने के लिए तभी पात्र होगा जब वह बिड देने वाला सक्षम प्राधिकारी के पास पंजीकृत हो। बिड में भाग लेते समय बिडर को इसका अनुपालन करना होगा और कोई भी गलत घोषणा किए जाने व इसका अनुपालन न करने पर अनुबंध को तत्काल समाप्त करने और कानून के अनुसार आगे की कानूनी कार्रवाई का आधार होगा।/In terms of GeM GTC clause 26 regarding Restrictions on procurement from a bidder of a country which shares a land border with India, any bidder from a country which shares a land border with India will be eligible to bid in this tender only if the bidder is registered with the Competent Authority. While participating in bid, Bidder has to undertake compliance of this and any false declaration and non-compliance of this would be a ground for immediate termination of the contract and further legal action in accordance with the laws.

---धन्यवाद/Thank You---



आईआरईएल (इंडिया) लिमिटेड

IREL (India) Limited

(पूर्वमेंइंडियनरेअरअर्थ्सलिमिटेड Formerly Indian Rare Earths Ltd.)

रेअरअर्थ्सप्रभाग Rare Earths Division,

उद्योगमंडल Udyogamandal, कोची Kochi-683501

CIN: U15100MH1950GOI008187

ISO 9001:2015, ISO 14001:2015, ISO 45001:2018 COMPANY

GST ID No. 32AAACI2799F2ZM



IREL/RED/P/26-27/00034

निविदा आमंत्रण सूचना NOTICE INVITING TO TENDER

SCHEDULE OF TENDER (SOT)

a.	Description of supply	Procurement of One Ton Jumbo Bag (Staggered Delivery)
b.	Mode of tender	Open tender invited in two parts. Part-I: Techno-Commercial Bid Part - II: Price Bid.
c.	Estimated Value	Rs.43,99,130/- (all inclusive)
d.	Earnest Money Deposit (EMD)	Rs.74,562/-
e.	Validity of Tender	90 days from the date of opening of Techno-Commercial bid.
f.	Contact details of tender inviting authority	HOD (Purchase) IREL (India)Limited, RE Division, Udyogamandal - 683 501, KERALA E-mail: purchase-red@irel.co.in Ph. No. 0484-2545199

NOTE

EMD EXEMPTION: For this tender, Under MSE category, only manufacturers for goods are eligible for exemption from EMD. Traders are excluded from the purview of this Policy. The bidder seeking EMD exemption, must submit the valid supporting document for the relevant category along with Udyam Certificate otherwise offer will be rejected without any further clarification.

1.0 BIDDING SYSTEMS

This is a two-part tender. The tenderers should bifurcate their quotations in two parts (Part-I & II).

PART-I “Techno-commercial bid”:

It contains the eligibility, technical quality and performance aspects, commercial terms and conditions and documents sought in the tender, **except the price and relevant financial details.**

PART-II “Financial bid”:

It contains the price quotation along with other financial details.

PART-I shall be opened first and evaluated by a committee constituted by competent authority.

PART-II: the financial bid of Techno-commercially eligible bidders shall be opened on recommendation of above committee on a notified date and time after sending advance notice to all qualified bidders for being present.

CONTACT PERSONS OF TENDERING AUTHORITY

Purpose	Name	E-mail ID	Contact No.
For Technical Specification / Scope of work related query	Shri. Amith P C DM- Technical (Production)	production-red@irel.co.in amith.pc@irel.co.in	8754559102
For Bid/tender related query	Shri. V.A. Anil Kumar DGM-Technical (Purchase)	purchase-red@irel.co.in	9443482644
	Shri. P. Mohan Deputy Officer (Purchase)		0484-2545199
For Consignment/Goods Transportation related query	Shri. Girish D Babu CM-Technical (operations)	stores-red@irel.co.in	91 8301997625
For Payment/refund related query	Shri. Goutham Samui DGM -Finance	finance-red@irel.co.in	0484-2546909

2.0 EARNEST MONEY DEPOSIT (EMD)/ BID SECURITY

- 2.1 Earnest Money Deposit (EMD) is a deposit received from the tenderers in token of their earnestness in submitting their offer to undertake the supplies/works/services/consultancy contracts and conclude a contract if entrusted to them on the basis of their tender. **The offers received from tenderers without EMD shall be summarily rejected except where an exemption is provided in the tender.**
- 2.2 EMD is to be remitted by way of 'Insurance Surety Bonds' or 'account payee demand draft' or 'fixed deposit receipt' or 'bankers cheque' or 'Bank Guarantee from any scheduled commercial Banks' or "online payment' in favour of IREL. In case of online payment, bidders should submit the UTR no. enabling verification of receipt of the amount.
- 2.3 Government Body/Public Sector Undertakings may be exempted from payment of EMD with the approval of Competent Authority.
- 2.4 EMD amount in rupee value is to be mentioned as a fixed amount in the tender and not as a percentage of the estimated cost and no interest is payable on the EMD.
- 2.5 EMD shall be exempted to MSEs and Start-ups as per prevailing guidelines in this regard. Under MSE category, only manufacturers for goods and Service Providers for Services are eligible for exemption from EMD.
- 2.6 EMD is liable to be forfeited if:
- a) The tenderer changes the terms and conditions or prices or withdraw his quotation subsequent to the date of opening/ the tenderer impairs or derogates from the tender in any respect within the period of validity of the tender
 - b) The tenderer fails to accept the order when placed or fails to commence supplies/works/services after accepting the order.
 - c) In case bidder submits false/fabricated documents. d) In case bidder fails to submit SD as stipulated in the tender.
- 2.7 EMD may be adjusted against security deposit / performance security of the successful bidder. EMD of the unsuccessful bidders shall be returned to them at the earliest after expiry of the final bid validity period and latest by the 30th day after the award of the contract. Bid security shall be refunded to the successful bidder on receipt of performance security. However, in case of two stage bidding/ 2or 3 envelope bidding, EMD of unsuccessful bidders during first stage i.e. technical evaluation etc. shall be returned within 30 days of declaration of result of first stage i.e. technical evaluation etc.
- 2.8 In case where the EMD is provided in form of BG in the prescribed format to be attached with the tender, the BG shall be obtained from a scheduled commercial Bank with validity of 45 days beyond final bid validity period

3.0 GUIDELINES FOR PROCUREMENT FROM MSEs

3.1 Procurement from Micro, Small and Medium Enterprises (MSEs):

The Procurement Policy for Micro and Small Enterprises, 2012 [as amended time to time] has been notified by the Government in exercise of the powers conferred in Section 11 of the Micro, Small and Medium Enterprises Development (MSMED) Act, 2006. In line with Government Policy, the prevailing guidelines in this regard as issued from time to time is to be strictly adhered to.

- 3.2 As per the Government notified Public Procurement Policy for Micro & Small Enterprises (MSE), it is mandated that 25% of procurement of annual requirement of goods and services will be sourced from the Micro and Small Enterprises.
- 3.3 In tender, participating Micro and Small Enterprises (MSE) quoting price within price band of L1+15 (fifteen) per cent shall also be allowed to supply a portion of requirement by bringing down their price to L1 price in a situation where L1 price is from someone other than a MSE and such MSE shall be allowed to supply up to 25(twenty-five) per cent of total tendered value. The 25(twenty - five) per cent quantity is to be distributed proportionately among these bidders, in case there are more than one MSEs within such price band.
- 3.4 Within this 25% (Twenty Five Percent) quantity, a purchase preference of four (4) per cent s reserved for MSEs owned by Scheduled Caste (SC)/ Scheduled Tribe (ST) entrepreneurs and three (3) percent is reserved for MSEs owned by women entrepreneur (if they participate in the tender process and match the L1 price).However, in event of failure of such MSEs to participate in tender process or meet tender requirements and L1 price, four percent sub-target for procurement earmarked for MSEs owned by SC/ST entrepreneurs and three (3) percent earmarked to women entrepreneur will be met from other MSEs.
- 3.5 MSEs would be treated as owned by SC/ ST entrepreneurs:
- a) In case of proprietary MSE, proprietor(s) shall be SC /ST;
 - b) In case of partnership MSE, the SC/ ST partners shall be holding at least 51% (fifty-one percent) shares in the unit;
 - c) In case of Private Limited Companies, at least 51% (fifty-one percent) share shall be held by SC/ ST promoters.
- 3.6 If subcontract is given to MSEs, it will be considered as procurement from MSEs.
- 3.7 In case of tender item cannot be split or divided, etc. the MSE quoting a price within the band L1+15% may be awarded for full/ complete supply of total tendered value to MSE, considering the spirit of the Policy for enhancing Govt. Procurement from MSEs.
- 3.8 Where any Aggregator has been appointed by the Ministry of MSME, themselves quote on behalf of some MSE units, such offers will be considered as offers from MSE units and all such facilities would be extended to these also.
- 3.9 **Traders/ distributors/ sole agent/ Works Contract are excluded from the purview of the policy.**
- 3.10 To reduce transaction cost of doing business, Micro and Small Enterprises is to be facilitated by providing them tender sets free of cost, exempting Micro and Small Enterprises from payment of Earnest Money (EMD), adopting e-procurement to bring in transparency in tendering process. However, exemption from paying Performance Security / Performance Bank Guarantee is not covered under the Public Procurement policy.
- 3.11 MSEs may also be given relaxation in prior turnover and prior experience criteria during the tender process, subject to meeting of quality and technical specifications. However, there may be circumstances (like procurement of items related to public safety, health, critical security operations and equipment, etc.) where the vendor having prior experience may be preferred rather than giving orders to new entities.

- 3.12 Payment to the MSME vendors is to be made within 30 days from the date of receipt and acceptance of goods/ services.
- 3.13 In case Bidder is a Micro or Small Enterprise under the Micro, Small and Medium Enterprises Development Act, 2006, the Bidder is to be asked for submitting the following along with tender: Ministry of MSME has notified criteria for classifying the enterprises as Micro, Small and Medium Enterprises as combination of investment in Plant & machinery or Equipment and Turnover. Mandatory registration in Udyam Registration Portal for all new and existing MSME has been prescribed. Accordingly, Micro and Small Enterprises (MSEs) shall be required to submit Udyam Registration Certificate for availing benefit.
- 3.14 To enhance MSME competitiveness, the Government of India envisioned the Zero Defect Zero Effect (ZED) initiative to make MSME sustainable and transform them as National and International Champions. MSME Sustainable (ZED) Certification is an extensive drive to create awareness amongst MSMEs about Zero Defect Zero Effect (ZED) practices and motivate & incentivise them for ZED Certification while also encouraging them to become MSME Champions.

The ZED (Zero Defect Zero Effect) Certification, a scheme by the Indian government for Micro, Small, and Medium Enterprises (MSMEs), offers numerous benefits, including financial incentives, improved quality and productivity, enhanced market access, and increased global competitiveness. For registration please visit <https://zed.msme.gov.in>

3.15 RXIL (TReDS) PLATFORM

IREL is registered with RXIL (TReDS) platform. MSE bidders are requested to get registered with RXIL (TReDS) platform to avail the facility as per the GOI guidelines.

IREL (India) Limited is onboard with TReDS platform of M/s RXIL for facilitating Bill Discounting for MSME's.

As per DPE/7(4)/2007-Fin dt 21/08/2020, it is mandatory to get all the MSME vendors registered on the platform.

Vendors can get themselves registered at: <https://onboarding.rxil.in/customerapp/home>.

The registration fees of MSMEs on TReDS Platform is Free of Cost as per the new guidelines provided by SIDBI.

For any registration queries, vendors may please contact,

RXIL Relationship manager Mr. Satyajee Jathar: +91 99201 00784 / +91 9004100784 *email:* satyajeet.jathar@rxil.in

RXIL Relationship manager Mr Kirti musale : +91 90048 17501 *email:* kirti.musale@rxil.in

DTX - KreDX Platform Private Limited (the 5th TReDX Platform) - Registration Number- COL75X754M2W

Prathamesh Varose: +91 -8600273564 *email:* prathamesh.varose@kredx.com

Jason Chongtham: +91 -9600063327 *email:* jason@kredx.com

M1xchange

a. Registration Number -BUYER00047728

b. Contact Person: Mr. Ankit K. Singh, 9800250394, *email:* ankit.singh@m1xchnage.com

Invoicemart

- a. Entity ID/Registration Number- 1000036436
 - b. Contact Person: Mr. Amith Dutta, 8600179668, email: Amit1.Dutta@invoicemart.com
- C2treds (C2FO)**
- a. Registration Number: B0320250094
 - b. Contact Person: Ms. Monalisa, 9220407665, email: monalisa.das@c2treds.com

IREL (India) Limited Unit Administrator Mr. V A Anil Kumar : +91 9443482644 email : purchase-red@irel.co.in

IREL (India) Limited Nodal Officer Mr. K.V.Ramakrishna: +918104997177 email: kramakrishna@irel.co.in

4.0 MAKE IN INDIA

For this procurement, Public Procurement (Preference to Make in India). Order 2017 dated 15.06.2017, 28.05.2018 & 29.05.2019 and subsequent Orders issued by the respective Nodal Ministry shall be applicable. The bidder has to provide certificate as a proof for minimum 50% and 20% local content required for qualifying Class 1 and Class 2 Local Supplier respectively.

5.0 SECURITY DEPOSIT (SD), PERFORMANCE BANK GUARANTEE & RETENTION MONEY

5.1 SECURITY DEPOSIT (PERFORMANCE SECURITY) & PERFORMANCE BANK GUARANTEE

- 5.1.1 Security deposit (SD) shall be uniformly levied @ 5% of contract value (excluding Taxes) towards satisfactory completion of the order/works as under:

For supply & service contract valued more than Rs.5 lakhs. Performance Security deposit is to be furnished by a specified date (generally 14 (fourteen) days after notification of the award) and it should remain valid for a period of 60 (sixty) days beyond the date of completion of all contractual obligations of the supplier/ contractor, including warranty obligations/ defect liability period (DLP).

- 5.1.2 Submission of SD/PBG, if called for in the tender can also be paid through Insurance Surety Bonds' or 'account payee demand draft' or 'fixed deposit receipt from a Scheduled Commercial bank' or 'Bank Guarantee issued/ confirmed from any Scheduled Commercial Banks in India' or online payment to be confirmed sharing Unique Transaction Reference (UTR) to the tender inviting authority as called for in tender.
- 5.1.3 Bank Guarantees towards Bid Security/ Security Deposit/ PBG issued by Nationalised Banks/ Scheduled Commercial Banks (other than Cooperative Banks) only acceptable.
- 5.1.4 EMD/ Bid Security may be adjusted towards SD. However, if EMD is submitted in the form of Bank Guarantee, fresh Bank Guarantee in the prescribed format or demand draft/ bankers cheque is to be submitted towards SD.
- 5.1.5 The SD shall not bear any interest and is liable to be forfeited for unsatisfactory completion or on abandonment of the supply/ work order.

5.3 SECURITY DEPOSIT

The total SD together towards performance guarantee shall not exceed 10% of contract value. The performance security should be refunded to the supplier/ contractor without interest, after he duly performs and completes the contract in all respects but not later than 60(sixty) days of completion of all such obligations including the warranty under the contract/ 365 days beyond DLP.

5.4 REFUND OF SD

a) Before releasing SD in respect of supplies/works, a “No Dues Certificate” shall be issued by EIC/OIC duly countersigned by Head of the department after ensuring that no amounts are recoverable from the supplier/ contractor.

b) EIC/OIC shall recommend release of SD and retention money after compliance by the contractor towards guarantee/ warranty/ performance guarantee & other related clauses as stipulated in the purchase/work order and on submission of formal claim by supplier/contractor.

c) On receipt of “no dues certificate” from EIC/OIC, SD or retention money may be refunded at the earliest, if the contractor is not liable to pay any money to IREL under any other contract.

5.5 **FORFEITURE OF SD**

The SD shall stand forfeited in favour of IREL, without any further notice to the contractor in the following circumstances:

- (i) In case of any failure whatsoever on the part of the Supplier/ Contractor at any time during performance of his part of the contract including the extended periods of contract, where notice is given and time for rectification allowed.
- (ii) If the Supplier/ contractor indulges at any time in any subletting/ subcontracting of any portion of the work without approval of IREL.

PART - I

TECHNO-COMMERCIAL BID

REQUIRED DOCUMENTS TO BE SUBMITTED ALONGWITH TECHNO-COMMERCIAL BID.

Sl. No.	Description	Up-loaded Yes/No
1	PROOF OF SUBMISSION OF EMD / VALID EXEMPTION CERTIFICATE (If Applicable).	
2	DOCUMENTS AS PER PRE-QUALIFICATION CRITERIA.	
3	DULY FILLED, SIGNED AND SEAL AFFIXED IREL TENDER DOCUMENTS (Techno-Commercial Bid) (Annexure- I to XI)	
4	COPY OF GST & PAN CERTIFICATES.	
5	ANY OTHER DOCUMENTS AS PER TENDER CONDITIONS.	

PRE-QUALIFICATION CRITERIA (POC)

1.0 TECHNICAL COMPETENCY

Bidder should have successfully supplied Jumbo bags of Minimum 500 Kg capacity/bag during the last 7 years ending May 2025 as per following and submit the purchase order copy along with Invoice copy/completion certificate as a proof of supply.

- a) One supply of minimum 1850 Jumbo bags of min. 500 Kg capacity each
- OR
- b) Two supply of minimum 1110 Jumbo bags (of min. 500 Kg capacity each) each

2.0 FINANCIAL COMPETENCY

Average Financial turnover of the party should not be less than Rs. 11.18 lakh during the past three financial years. To verify the same, bidder shall submit copies of P&L Account Statement of the company for the past three financial years etc.

- 3.0 Bidder should accept our technical specification, SCOC and no deviation statement form to be submitted

**Documents against the Pre-qualification criteria as above complete in all respects must be uploaded
Failure to compliance of above shall make the bid incomplete and as such it shall be rejected**

SPECIAL CONDITIONS OF CONTRACT (SCOC)

1.0 SCOPE OF SUPPLY

The successful bidder has to supply the material as per technical specification in Annexure-IIA Annexure-II B, Annexure-II C and bill of quantities (BOQ).

2.0 PERIOD OF CONTRACT AND DELIVERY SCHEDULE

- 2.1 The period of supply shall be 270 days from the date of receipt of order.
- 2.2 The supply shall be made on staggered delivery basis. First lot should contain approximately 40% of total ordered quantity and to be dispatched within 90 days of placement of order. Next 30% of the second lot be dispatched within next 3 months after placing the first lot and the balance 30 % of the lot to be dispatched within 3 months after completion of the second lot.
- 2.3 The successful bidders has to deliver the goods to General Stores Department, IREL (India) Limited, RE Division, Udyogamandal.
- 2.4 The supplier shall ensure that delivery of goods is accompanied by delivery note/ GST Invoice which shows the order details, date, and the type and quantity of goods including HSN Code.

3.0 PAYMENT TERMS

- 3.1 100% less statutory deduction will be released within 30 days of receipt and after acceptance of material at our Stores by Engineer In-Charge against each lot of supply.
- 3.2 Payment will be released within 30 days of receipt and acceptance of all the bags at our Stores after acceptance by Officer In-Charge.
- 3.3 The successful bidder has to submit the following documents for releasing the payment.
- 3.6.1 Tax invoice / E-invoice/ way bill of the supplier / supplier certified by OIC.
- 3.6.2 Any other documents as per EIC's instructions.

4.0 OFFICER-IN-CHARGE (OIC)

Shri. Amith P C, DM- Technical (Production) will be the officer-in-charge.

5.0 SECURITY DEPOSIT

Security deposit (SD) shall be uniformly levied @ 5% of the contract value (excluding tax) towards satisfactory completion of order. Security deposit is to be furnished by a specified date (generally 14 (fourteen) days after notification of the award) and its all remain valid for a period of 60(sixty) days beyond the date of completion of all contractual obligation of the supplier/contractor, including warrantee obligation / defect liability period (DLP)

6.0 TENTATIVE DELIVERY SCHEDULE

SL No	Lot No	Quantity in Numbers	Delivery Date
1	First lot	1480	90 Days from the date of Placement of order.
2	Second lot	1110	180 Days from the date of Placement of order.
3	Third lot	1110	270 Days from the date of Placement of order.

Note: Bags to be supplied for each lot on priority as per BOQ, shall be intimated to the successful bidder via email.

7.0 BILL OF QUANTITIES (BOQ)

Sl. No.	Description	Product name	Qty	Unit
1	Size: 90 X 90 X 110 cm One ton Jumbo bag with inner liner and discharge spout as per attached Technical specification Annexure-IIA and IIC	Lanthanum Carbonate	1000	Numbers
2	Size: 90 X 90 X 110 cm One ton Jumbo bag with inner liner and discharge spout as per attached Technical specification Annexure-IIA and IIC	Cerous Carbonate	950	Numbers
3	Size: 90 X 90 X 110 cm One ton Jumbo bag with inner liner and discharge spout as per attached Technical specification Annexure-IIA and IIC	NdPr Oxalate	500	Numbers
4	Size: 90 X 90 X 110 cm One ton Jumbo bag with inner liner and discharge spout as per attached Technical specification Annexure-IIA and IIC	Samarium Oxalate	25	Numbers
5	Size: 90 X 90 X 110 cm One ton Jumbo bag with inner liner and discharge spout as per attached Technical specification Annexure-IIA and IIC	Gadolinium Oxalate	25	Numbers
6	Size: 90 X 90 X 110 cm One ton Jumbo bag with inner liner and discharge spout as per attached Technical specification Annexure-IIA and IIC	Without Name	700	Numbers

7	One ton Jumbo bag with Flap/top lid, SIZE 100 x 100 x 115 and without liner as per attached Technical specification Annexure-IIB and IIC	Without Name	500	Numbers
---	--	--------------	-----	---------

8.0 DETAILS TO BE FURNISHED ALONE WITH THE OFFER

SI. No	Description of item	GST in %	HSN Code
1	Size: 90 X 90 X 110 cm One ton Jumbo bag with inner liner and discharge spout as per attached Technical specification Annexure-IIA and IIC		
2	Size: 90 X 90 X 110 cm One ton Jumbo bag with inner liner and discharge spout as per attached Technical specification Annexure-IIA and IIC		
3	Size: 90 X 90 X 110 cm One ton Jumbo bag with inner liner and discharge spout as per attached Technical specification Annexure-IIA and IIC		
4	Size: 90 X 90 X 110 cm One ton Jumbo bag with inner liner and discharge spout as per attached Technical specification Annexure-IIA and IIC		
5	Size: 90 X 90 X 110 cm One ton Jumbo bag with inner liner and discharge spout as per attached Technical specification Annexure-IIA and IIC		
6	Size: 90 X 90 X 110 cm One ton Jumbo bag with inner liner and discharge spout as per attached Technical specification Annexure-IIA and IIC		
7	One ton Jumbo bag with Flap/top lid, SIZE 100 x 100 x 115 and without liner as per attached Technical specification Annexure-IIB and IIC		

TECHNICAL SPECIFICATION**One Ton Jumbo Bag with inner liner and discharge spout (Drawing No. 02 attached)**

1	Fabric	Polypropylene woven, circular, 3% UV stabilized and coated, with discharge spout.	
2	Fabric Thickness	Body :220 GSM polypropylene, pre UV stabilized Base :250 GSM polypropylene, pre UV stabilized	
3	Coating	120 gauge Polypropylene	
4	Liner	There shall be two liners: One 320 gauge LD polythene 2%UV stabilized liner glued to the inside of the walls of the bag with both end open(while discharging the material, liner should not come with the material) One 320 gauge LD polythene 2%UV stabilized liner loosely inserted and blown with air with both end opened.	
5	Bag Size for 1 MT capacity	90 X 90 X 110 cm	
6	Printing on Bag	As per table below	
7	Transparent polythene side pocket for each jumbo bag (with one side open)	Used for inserting product data sheet: 15 X 10 cm	
8	Filling Spout	40 cm dia. x 50 cm length	
9	Bottom Discharge	50 cm dia. x 60 cm length with Pajama thread for opening	
10	Lifting Loops & String	Four Loops, 40 cm height from the edge of the jumbo bag	
11	Loop options	Full length bottom running	
12	Stitching	Herakel and safety stitch (edges of the bag to be folded before stitching & should be double stitched).	
13	SWL	1000 Kg	
14	Safety Factor	5:1	
15	Test Certificate	For each bag test certificate to be displayed/fused on the bag	
16	Product Name (Specific name given for different products & to be printed on each of the Jumbo bag)	Polythene color label of size 15 x 10cm shall be displayed at the centre on all four sides of each of the Jumbo bag at the top edge in the form of an identification colour mark. Only one side of the colour polythene sheet needs to be stitched.	
	Lanthanum Carbonate	Colour label	Required quantity, Nos.
	Cerous Carbonate	Green	1000
	Neodymium Praseodymium Oxalate	Blue	950
	Samarium Oxalate	Red	500
	Gadolinum Oxalate	Yellow	25
	Without Name (No name required)	Ash	25
	Weight of each bag	Colourless (No colour label required)	700
17	Weight of each bag	4 Kg +/- 5% tolerance	
18	Inspection Certificate	Inspection shall be carried out by third party by Indian	

		Institute of Packaging or any government certified agency accredited by NABL. Test Certificate has to be provided by the supplier at the time of delivery of bags along with test result. Over & above all relevant IS specification including following shall be followed: (a) IS 14738-1999 part 3 & 4.
--	--	---

Annexure-IIB

TECHNICAL SPECIFICATION

Jumbo bag with Flap/top lid, SIZE 100 x 100 x 115 Cm (Drawing No. 03 attached)

1.	Fabric	Polypropylene woven, circular, 3% UV stabilized and coated, without discharge spout	
2.	Fabric thickness	Body: 220 GSM polypropylene, pre UV stabilized Base: 230 GSM polypropylene, pre UV stabilized	
3.	Coating	120 gauge PP	
4.	Liner	There shall be no liners inside.	
5.	Bag Size	100 x 100 x 115 cm	
7.	Filling spout	100 x 100 x 115 cm with flap.	
8.	Discharge spout	Nil (Flat bottom with filler cord only)	
9.	Lifting options	Four loops 40cm height from the edge of the jumbo bag	
10.	Loop options	Full length bottom running	
11.	Stitching	Herakle and safety stitch	
12.	SWL	1000 kg	
13.	Safety factor	5:1	
14.	Printing	Not required	
15.	Test certificate	For each bag test certificate to be displayed / fused on the bag.	
16.	Product Name (Specific name given for different products & to be printed on each of the Jumbo bag)	Colour label	Required quantity, Nos.
	Without Name (No name required)	Colourless (No colour label required)	500
17.	Plain Jumbo bags should be packed in bundles / bales of 25 bags. Bale numbers are to be provided in serial numbers		
	Weight of each bag	3 Kg +/- 5% tolerance	
18.	Inspection Certificate	Inspection shall be carried out by third party by Indian Institute of Packaging or any government certified agency accredited by NABL. Test Certificate has to be provided by the supplier at the time of delivery of bags along with test result. Over & above all relevant IS specification including following shall be followed: (a) IS 14738-1999 part 3 & 4.	

PRINTING DETAILS (FONT-	
SIDE - 1 (Font- 30 mm)	SIDE - 2 (Font- 30 mm)
Product / Material Name:	IREL (India) Limited UDYOGAMANDAL COCHIN, INDIA
Product Name	
BAG No:	
GROSS: KGS	
NET :	KGS

DRAWING NO: 01

.....
Signature and seal of the contractor

.....
Page **16** of **37**

SIDE VIEW

Polythene colour label of size 15cm*10cm. Only one side to be stitched and colour will be specified as per the product name

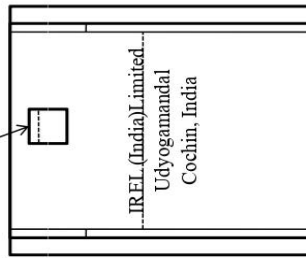

SIDE1

Polythene colour label of size 15cm*10cm. Only one side to be stitched and colour will be specified as per the product name

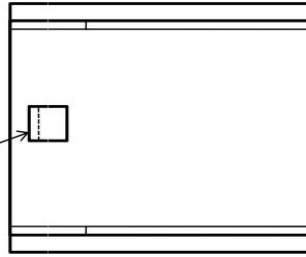

SIDE2

Transparent polythene side pocket of size 15cm*10cm, used for inserting the product data sheet

Polythene colour label of size 15cm*10cm. Only one side to be stitched and colour will be specified as per the product name

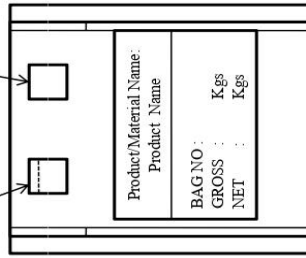

SIDE3

Polythene colour label of size 15cm*10cm. Only one side to be stitched and colour will be specified as per the product name

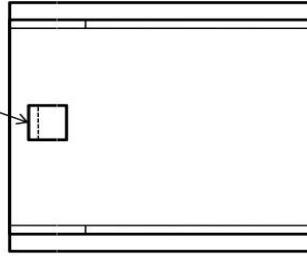

SIDE4

DRAWING NO: 02

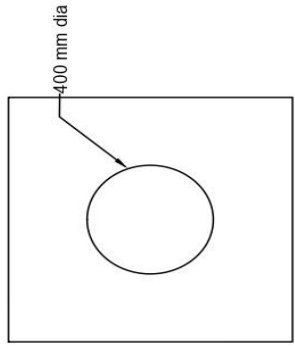
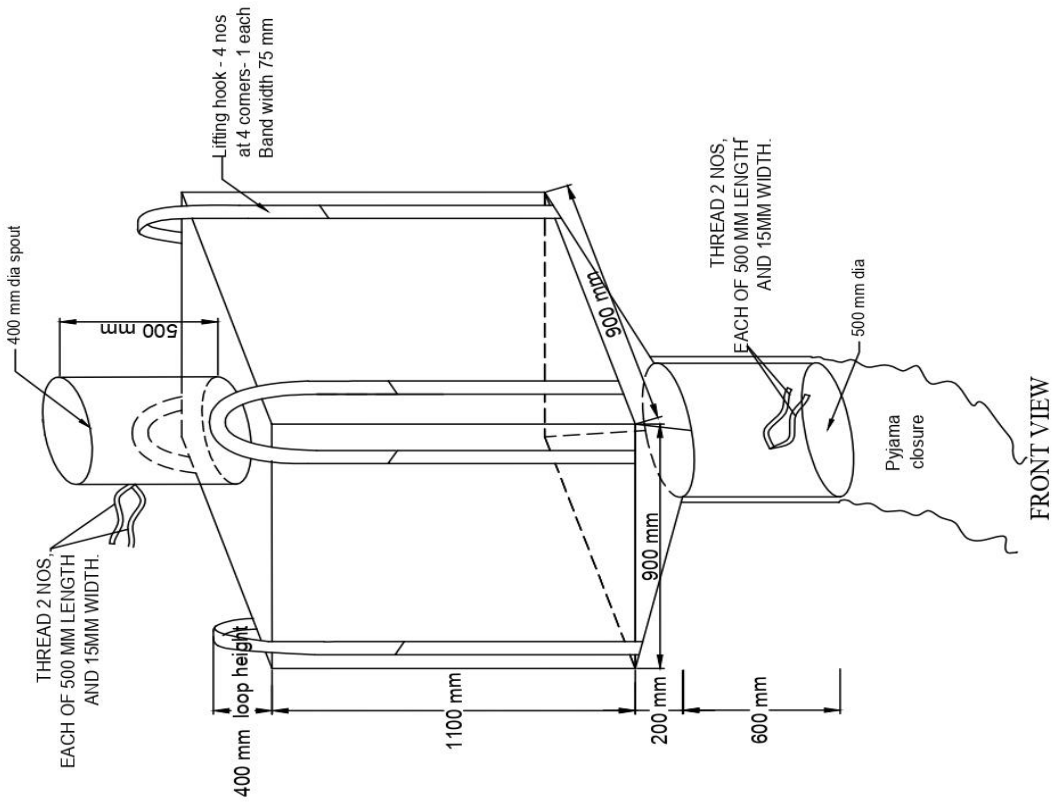

TOP VIEW

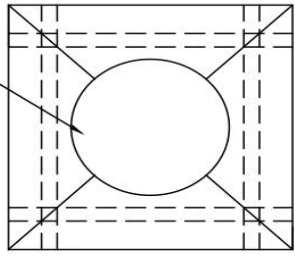

BOTTOM VIEW



IREL (India) Limited
R.E. DIVISION, UDYOGAMANDAL

Date	29.01.2024
Scale	NTS
Drawn AP	
Checked TSM	
Apprvd. SKP	

PRODUCT JUMBO BAG WITH DISCHARGE SPOUT

Dwg.No. IRE/RED/Civil/24-02

Sheet 1 of 1

DRAWING NO: 03

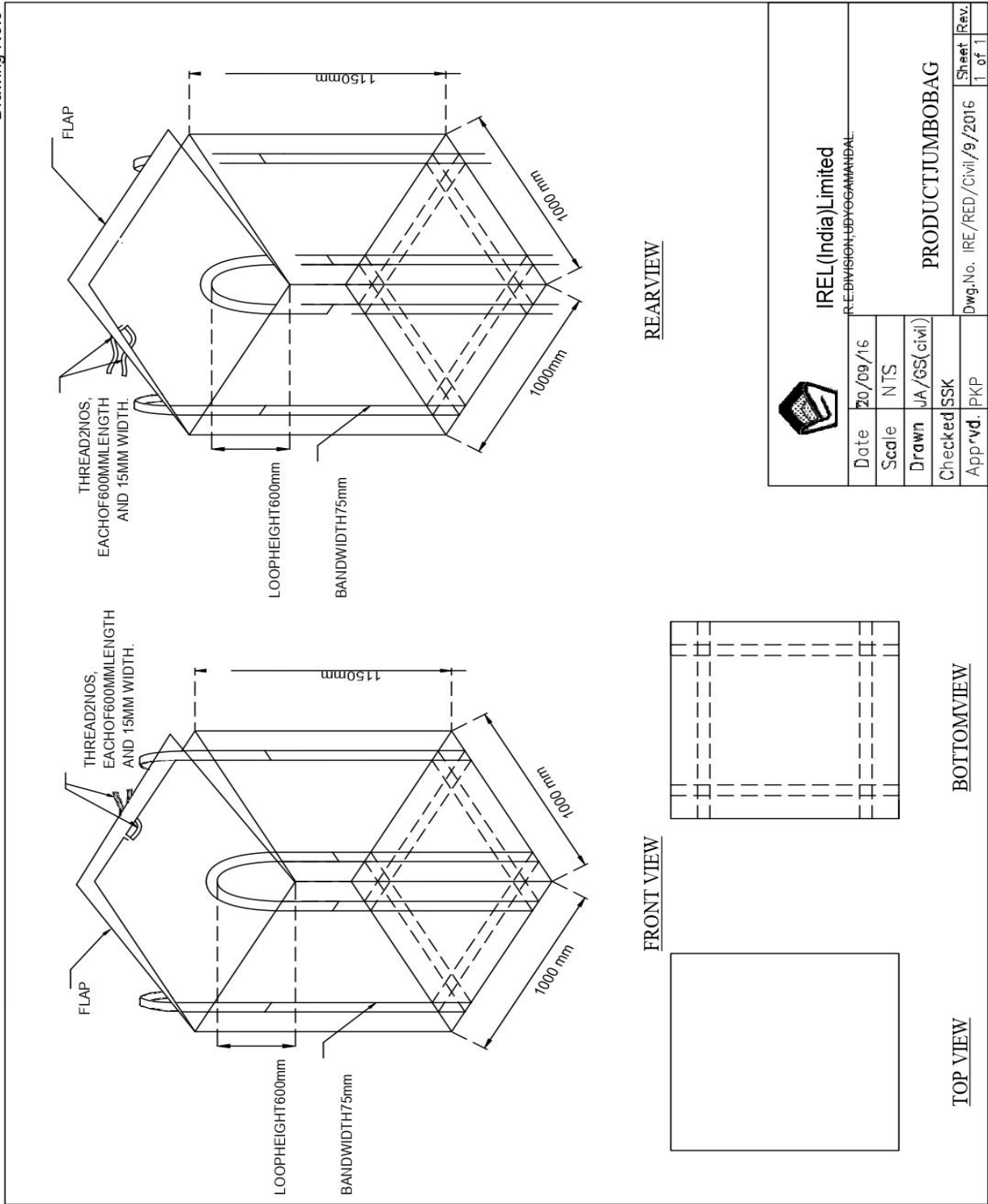

IREL (India) Limited

R.E. DIVISION, UDYOGAMANDAL

Date 20/09/16

Scale NTS

Drawn JA/SS(civil)

Checked SSK

App^{rd.} PKP

PRODUCT JUMBOS BAG

Dwg.No. IRE/RED/Civil/9/2016

Sheet Rev. 1 of 1

आईआरईएल (इंडिया) लिमिटेड IREL (India) Limited

रेअरअर्थ्सप्रभाग Rare Earths Division

TECHNICAL DEVIATION STATEMENT FORM

TENDER NO:
Name of Work:

The bidder has to quote as per technical specification and requirement of the bid. No deviation is expected. However in case of any deviation, the same has to be recorded clearly in the technical deviation statement form.

The following are the particulars of deviations from the requirements of the Tender specifications.

CLAUSE	DEVIATION (Including Justification)	REMARKS

Signature & Seal of the Tenderer

Dated:

Note:

- Where there is no deviation, the statement should be returned duly signed with an endorsement indicating 'No deviations'. If not endorsed, it will be considered as 'No deviation'.
- The technical specifications furnished in the Tender document shall prevail over those of any other document forming a part of our Tender, except only to the extent of deviations furnished in the statement.

Annexure-IV

.....
Signature and seal of the contractor

Page 20 of 37

"ETHICS IN TENDERING & OTHER BUSINESS DEALINGS"

Dear Sir,

IREL (India) LIMITED, a Government of India undertaking under the administrative control of Department of Atomic Energy is doing its business as per the rules and regulation of the Public Sector Undertaking and other statutory agencies. The business is done in an ethical, rational & impartial manner with good corporate governance.

In our endeavour to be more transparent in our dealings and to support our ideology all Vendors, Customers and Business Partners are requested not to provide any gift and / or inducement to any of our employees for securing / being granted favour in dealings with our Company. In assurance of your commitment to the aforesaid, it will be highly appreciated if you fill up, sign and abide by the attached undertakings.

Report of any gifts and / or inducements sought by any employee of the company should be immediately reported to any one of the following:

Chairman & Managing Director IREL (India) Limited 1207, V.S. Marg, Prabhadevi Mumbai 400 028. Ph.: 022-24225778 E-mail: cmd@irel.co.in	Chief Vigilance Officer IREL (India) Limited 1207, V.S. Marg, Prabhadevi Mumbai 400 028. Ph.: 022-24221068 E-mail: cvo@irel.co.in
---	--

We assure you that complaints if any made by you on the subject will be kept confidential and fair investigation will be conducted and appropriate action will be taken. Similarly, we accept your commitment to the undertaking and its violation will have consequences as per prevailing rule of the Company.

Thanking you,

For IREL (India) Limited

Name -----

Designation -----

Date:

Annexure-V

.....
Signature and seal of the contractor

Page 21 of 37

UNDERTAKING TO BE SUBMITTED BY BIDDERS FOR ADOPTING ETHICAL PRACTICES

Date:

IREL (India) Limited
1207, V.S. Marg, Prabhadevi
Mumbai 400 028.

I / We Am / are a Vendor / Customer of IREL (India) Limited (now onwards to be referred as Company).

I / We agree and undertake:

Not to provide any gift and / or inducement to any employee of the Company in connection with securing / being granted favour (s) in my / our dealings with the Corporate office of the company and / or its any field units namely MK, Chavara, OSCOM, RED & IRERC.

To immediately report any gift and / or inducement sought by any employee of the Company granting favour(s) to me / us in my / our dealings with the Company and / or its field units.

Signature.....

Name.....

Title.....

Name of the Company and Address (with Seal).....

Annexure - VI

EMD DECLARATION

I have furnished a sum of Rs./- (Rupees.....only) towards EMD vide NEFT/RTGS/BG No..... dated.....

Place:

Signature of tenderer:

Full Address:

IREL Bank Details

Name of Bank	State Bank of India, Udyogamandal Branch, Udyogamandal
Account Type	Current Account
Name of Account holder	IREL(India) Limited
Account Number	57017844321
IFSC Code	SBIN0070158
MICR Code	682002926

Details of payment to be uploaded as attachment during tender submission and the same shall be e-mailed to: purchase-red@irel.co.in

Bidders (Pl. Provide the details):

1. Name of the Bank :
-
2. Account Type :
3. Account Number :
4. IFSC Code :

Annexure-VII

.....
Signature and seal of the contractor

Page 23 of 37

VENDOR UP-DATION DETAILS

SI #	Organisation Details		
1	Name		
2	Address Type (sales office address/office address/Warehouse address/factory address)		
3	Building/House Number		
4	Area/Street Name		
5	City		
6	Pin Code		
7	State		
8	Contact Details	Ph No:	
		Mobile No.	
		Email:	
9	Ownership Information (Private Limited Company/ One Person Company/ Limited Liability Partnership/ Partnership Firm / Proprietorship/ Co-Operative Society/ Trust/ Others)		
10	Nature Of Business (Manufacturer/ Dealer/ Trader/ Distributor/ Stockiest/ Channel Partner/ Indian Sales Office/ Subsidiary of Registered foreign supplier/ Indian Agents/ Service Provider)		
11	Copy of PAN card		
12	GSTIN		
13	Audited copies of P&L for the last three years		
14	Valid MSE Udyam registration certificate, if any.		Yes No
15	ISO Certification if any		
16	Registered in GEM Portal	Yes	No
17	Whether Supplier/Service Provider is a Start-Up Enterprise. If yes provide the details.		
Bank Details			
18	Name of bank:		
19	Name of Bank Branch:		
20	City/Place:		
21	Account Number:		
22	Account Type:		
23	IFSC Code:		
24	MICR Code:		

Annexure-VIII

.....
Signature and seal of the contractor

Page 24 of 37

DECLARATION - NON-BLACKLISTING

(To be submitted by an Authorized Signatory on the company's original letter head with signature and seal)

To,

**CM -Technical (Purchase)
IREL (India) Limited
R E Division, Udyogamandal - 683 501
KERALA**

Sir,

In response to the Bid Ref No.: _____ dated _____ 2023, I/We hereby declare that presently our agency has not been declared ineligible or black listed for corrupt & fraudulent practices either indefinitely or for a particular period of time by any State Govt./ Central Govt./PSU/Government of India Society on the date of bid submission.

If this declaration is found to be incorrect then without prejudice to any other action that may be taken, my/ our bid if any, to the extent accepted may be cancelled.

Thanking you,

Yours
faithfully,

Name of the agency: -
Authorized Signatory: -
Seal of the Organization: -

Annexure - IX

.....
Signature and seal of the contractor

.....
Page 25 of 37

GENERAL CONDITIONS OF CONTRACT (GCOC)
INDEX

Sl. No.	Particulars
1	DEFINITIONS
2	SELLER TO INFORM
3	CONFLICT AND INTERPRETATION OF DOCUMENTS
4	COUNTRY OF ORIGIN
5	SCOPE OF CONTRACT
6	STANDARDS
7	INSTRUCTIONS, DIRECTION & CORRESPONDENCE, CONTRACT OBLIGATIONS
8	MODIFICATION IN CONTRACT
9	PATENT RIGHTS, LIABILITY & COMPLIANCE OF REGULATIONS
10	INSPECTION, TESTING & EXPEDITING
11	TIME SCHEDULE & PROGRESS REPORTING
12	DELIVERY & DOCUMENTS
13	TRANSIT RISK INSURANCE
14	TRANSPORTATION
15	INCIDENTAL SERVICES
16	SPARE PARTS, MAINTENANCE TOOLS, LUBRICANTS
17	GUARANTEE
18	PRICES
19	SUBLETTING AND ASSIGNMENT
20	TIME AS ESSENCE OF CONTRACT
21	DELAYS IN THE SELLER'S PERFORMANCE
22	LIQUIDATED DAMAGES FOR DELAYED DELIVERY
23	REJECTIONS, REMOVAL OF REJECTED EQUIPMENT & REPLACEMENT
24	TERMINATION FOR DEFAULT
25	FORCE MAJEURE
26	RESOLUTION OF DISPUTES/ ARBITRATION
27	TAXES & DUTIES
28	PERMITS & CERTIFICATES
29	FALL CLAUSE
30	LIMITATION OF LIABILITY
31	METHOD OF BLACKLISTING VENDORS
32	SECRECY
33	GENERAL
34	RISK PURCHASE CLAUSE

Acceptance of GENERAL CONDITIONS OF CONTRACT (GCOC) Clause.no. 1 to 34

Signature & Seal of the Tenderer

Dated:

General Conditions of Contract (GCC-Goods)

Definitions In this document, General Conditions of Contract (GCC-Goods), the following terms shall have the following respective meanings:

.....
Signature and seal of the contractor

.....
Page 26 of 37

- 1.0 BIDDER: Designates the individual or legal entity which has made a proposal, a tender or a bid with the aim of concluding a Contract with the PURCHASER.
- 1.1 CONSULTANT [if engaged] shall mean M/s.having its registered office at..... The term consultant includes successors, assigns of M/s.
- 1.2 CONTRACT shall mean Purchase Order/ Service Contracts and all attached exhibits and documents referred to therein and all terms and conditions thereof together with any subsequent modifications thereto.
- 1.3 CONTRACT PRICE shall mean the price payable to the Seller under the Contract for the full and proper performance of his contractual obligations.
- 1.4 COMPLETION DATE shall mean the date on which the goods are successfully supplied/ commissioned by the Seller and handed over to the PURCHASER.
- 1.5 COMMERCIAL OPERATION shall mean the condition of the operation in which the complete equipment covered under the Contract is officially declared by the PURCHASER to be available for continuous operation at different loads up to and including rated capacity.
- 1.6 DELIVERY terms shall be interpreted as per INCO TERMS 2000 in case of Contract with a foreign Bidder and as the Goods-in-ward date in the case of a contract with an Indian Bidder.
- 1.7 DRAWINGS shall mean and include Engineering drawings, sketches showing plans, sections and elevations in relation to the Contract together with modifications and/or revisions thereto.
- 1.8 OFFICER-IN-CHARGE(OIC)/ENGINEER-IN-CHARGE(EIC): OFFICER-IN-CHARGE (OIC) / Engineer-in-Charge of the Project SITE shall mean the person designated from time to time by PURCHASER/CONSULTANT at SITE and shall include those who are expressly authorized by him/her to act for and on his/her behalf for operation of this CONTRACT.
The Officer/ Engineer-in-charge shall have authority for
- General supervision, Follow up of supply and direction of the work
 - direction to stop the work whenever such stoppage may be necessary to ensure the proper execution of the Contract
 - to reject all works and materials which do not conform to the contract The OIC/EIC shall have neither any authority to relieve the contractor of any of his duties / obligations under the contract nor ordering any work involving delay or any extra payment by IREL or making any variation of or in the work except otherwise expressly provided here-in-under or elsewhere in the contract.
- 1.9 FINAL ACCEPTANCE shall mean the PURCHASER's written acceptance of the Works performed under the Contract after successful completion of performance and guarantee test.
- 1.10 GOODS shall mean articles, materials, equipment, design and drawings, data and other property to be supplied by Seller to complete the contract.
- 1.11 INSPECTOR shall mean any person or outside Agency nominated by PURCHASER/CONSULTANT through CONSULTANT to inspect equipment, stagewise as well as final, before dispatch, at SELLER's works and on receipt at SITE as per terms of the CONTRACT.
- 1.12 INITIAL OPERATION shall mean the first integral operation of the complete equipment covered under the Contract with sub-systems and supporting equipment in service or available for service.
- 1.13 PURCHASER shall mean IREL (India) Limited (IREL) having its registered office at Plot No. 1207, Veer Savarkar Marg, Near Siddhi Vinayak Temple, Prabhadevi, Mumbai -400028. The term PURCHASER includes successors, assigns of IREL.
- 1.14 PERFORMANCE AND GUARANTEE TESTS shall mean all operational checks and tests required to determine and demonstrate capacity, efficiency and operating characteristics as specified in the Contract documents.
- 1.15 PROJECT designates the aggregate of the Goods and/or Services to be provided by one or more Contractors.
- 1.16 QUANTITIES - Bills of quantities designate the quantity calculations to be taken into account when these calculations are made from detailed or construction drawings, or from work actually performed, and presented according to a jointly agreed breakdown of the Goods and/or Services.
- 1.17 SELLER shall mean the person, firm or company with whom PURCHASE ORDER/ SERVICE CONTRACT is placed/ entered into by PURCHASER for supply of equipment, materials and services. The term Seller includes its successors and assigns.
- 1.18 SERVICE shall mean erection, installation, testing, commissioning, provision of technical assistance, training and other such obligations of the Seller covered under the Contract.
- 1.19 SITE designates the land and/or any other premises on, under, in or across which the Goods and/or Services have to be supplied, erected, assembled, adjusted, arranged and/or commissioned.
- 1.20 SPECIFICATIONS shall mean and include schedules, details, description, statement of technical data, performance characteristics, standards (Indian as well as International) as applicable and specified in the Contract.
- 1.21 SUB-CONTRACT shall mean order placed by the Seller, for any portion of the contracted work, after necessary consent and approval of PURCHASER.
- 1.22 SUB-CONTRACTOR shall mean the person named in the CONTRACT for any part of the work or any person to whom any part of the CONTRACT has been sub-let by the SELLER with the consent in writing of the CONSULTANT/PURCHASER and will include the legal representatives, successors, and permitted assigns of such person.
- 1.23 START-UP shall mean the time period required to bring the equipments covered under the Contract from an inactive condition, when construction is essentially complete to the state of readiness for trial operation. The start-up period shall include preliminary inspection and check out of equipment and supporting subsystems, initial operation of the complete equipments covered under the Contract to obtain necessary pre-trial operation data, perform calibration and corrective action, shutdown inspection and adjustment prior to the trial operation period.
- 1.24 TESTS shall mean such process or processes to be carried out by the Seller as are prescribed in the Contract or considered necessary by PURCHASER or his representative in order to ascertain quality, workmanship, performance and efficiency of equipment or part thereof.
- 1.25 TESTS ON COMPLETION shall mean such tests as prescribed in the Contract to be performed by the Seller before the Works are taken over by the PURCHASER.
- 2.0 **SELLER TO INFORM:**
The Seller shall be deemed to have carefully examined all contract documents to his entire satisfaction. Any lack of information shall not in any way relieve the Seller of his responsibility to fulfil his obligation under the Contract.
- 3.0 **CONFLICT AND INTERPRETATION OF DOCUMENTS:**
- 3.1 Words imparting the singular only also include the plural and vice versa where the context requires so; words imparting persons include firms or corporations and vice versa where the context requires.
- 3.2 Word imparting masculine gender includes the feminine gender and vice versa where the context requires so.
- 3.3 The several documents forming the contract are to be taken as mutually explanatory of one another.
- 3.4 In case conflicting statements or directives occur among the contract documents, it shall be the responsibility of the successful bidder to notify IREL, with a copy sent concurrently to the OIC/EIC, immediately in writing and obtain instructions from IREL to eliminate the conflict.
- 3.5 The successful bidder shall notify IREL, with a copy sent concurrently to the EIC/OIC, promptly of any discrepancies, omissions or doubts it may have, regarding drawings, specifications or other documents. Noted or calculated dimensions shall always be followed
- 3.6 In the event of conflict between various documents forming the contract, the relevant terms and conditions of the purchase order shall prevail over those of all such other documents forming the contract and binding on the contractor and IREL.
- 3.7 In case of any conflict between the General Conditions of contract and the Special Conditions of the contract, the Special Conditions of contract shall prevail.
- 4.0 **Country of Origin:** For purposes of this Clause "Origin" means the place where the Goods were produced, or from which the services are supplied. Goods are produced when, through manufacturing, processing or substantial and major assembling of components, a commercially recognized new product results that is substantially different in basic characteristics or in purpose or utility from its components.
- 5.0 **SCOPE OF CONTRACT:**
- 5.1 Scope of the CONTRACT shall be as defined in the PURCHASE ORDER/CONTRACT specifications, drawings and Annexure thereto.
- 5.2 Completeness of the EQUIPMENT shall be the responsibility of the SELLER. Any equipment, fittings and accessories which may not be specifically mentioned in the specifications or drawings, but which are usual or necessary for the satisfactory functioning of the equipment (successful operation and functioning of the EQUIPMENT being SELLER's responsibility) shall be provided by SELLER without any extra cost.
- 5.3 The SELLER shall follow the best modern practices in the manufacture of high grade EQUIPMENT notwithstanding any omission in the specifications. The true intent and meaning of these documents is that SELLER shall in all respects, design, engineer, manufacture and supply the equipment in a thorough workmanlike manner and supply the same in prescribed time to the entire satisfaction of PURCHASER.
- 5.4 The SELLER shall furnish minimum three (03) copies in English language of Technical documents, final drawings, preservation instructions, operation and maintenance manuals, test certificates, spare parts catalogues for all equipment to the PURCHASER.
- 5.5 The documents once submitted by the SELLER shall be firm and final and not subject to subsequent changes. The SELLER shall be responsible for any loss to the PURCHASER/CONSULTANT consequent to furnishing of incorrect data/drawings.

- 5.6 All dimensions and weight should be in metric system.
- 5.7 All equipment to be supplied and work to be carried out under the CONTRACT shall conform to and comply with the provisions of relevant regulations/Acts (State Government or Central Government) as may be applicable to the type of equipment/work carried out and necessary certificates shall be furnished.
- 5.8 The Seller shall provide cross sectional drawings, wherever applicable, to identify the spare part numbers and their location. The size of bearings, their make and number shall be furnished by the SELLER.
- 5.9 Specifications, design and drawings issued to the SELLER along with NIT/RFQ and CONTRACT are not sold or given but loaned. These remain property of PURCHASER/CONSULTANT or its assigns and are subject to recall by PURCHASER/CONSULTANT. The SELLER and his employees shall not make use of the drawings, specifications and technical information for any purpose at any time except for manufacture against the CONTRACT and shall not disclose the same to any person, firm or corporate body, without written permission of PURCHASER/CONSULTANT. All such details shall be kept confidential.
- 5.10 SELLER shall pack, protect, mark and arrange for despatch of EQUIPMENT as per instructions given in the CONTRACT.

6.0 **STANDARDS**

The GOODS supplied under the CONTRACT shall conform to the standards mentioned in the Technical Specifications, or such other standards which ensure equal or higher quality, and when no applicable standard is mentioned, to the authoritative standard appropriate to the GOODS' country of origin and such standards shall be the latest issued by the concerned institution.

7.0 **Instructions, Direction & Correspondence**

- 7.1 The materials described in the CONTRACT are to be supplied according to the standards, data sheets, tables, specifications and drawings attached thereto and/or enclosed with the CONTRACT, itself and according to all conditions, both general and specific enclosed with the contract, unless any or all of them have been modified or cancelled in writing as a whole or in part.
- a. All instructions and orders to SELLER shall, excepting what is herein provided, be given by PURCHASER/CONSULTANT.
- b. All the work shall be carried out under the direction of and to the satisfaction of PURCHASER/CONSULTANT.
- c. All communications including technical/commercial clarifications and/or comments shall be addressed to CONSULTANT in quintuplicate with a copy to PURCHASER and shall always bear reference to the CONTRACT.
- d. Invoices for payment against CONTRACT shall be addressed to PURCHASER. The CONTRACT number shall be shown on all invoices, communications, packing lists, containers and bills of lading, etc.
- e. Invoice must contain seller's GST Registration number, PAN, Bank detail of supplier, GST Registration number of IREL Factory/ Office, HSN Code for products being supplied. Supplier must submit e-way bill, e-invoice from GSTM Portal.

7.2 **Contract Obligations:**

- 7.2.1 If after award of the contract, the Seller does not acknowledge the receipt of award or fails to furnish the performance guarantee within the prescribed time limit, the PURCHASER reserves the right to cancel the contract and apply all remedies available to him under the terms and conditions of this contract.
- 7.2.2 Once a contract is confirmed and signed, the terms and conditions contained therein shall take precedence over the Seller's bid and all previous correspondence.

8.0 **Modification in Contract:**

- 8.1 All modifications leading to changes in the CONTRACT with respect to technical and/or commercial aspects including terms of delivery, shall be considered valid only when accepted in writing by PURCHASER/CONSULTANT by issuing amendment to the CONTRACT. Issuance of acceptance or otherwise in such cases shall not be any ground for extension of agreed delivery date and also shall not affect the performance of contract in any manner except to the extent mutually agreed through a modification of contract.
- 8.2 PURCHASER/CONSULTANT shall not be bound by any printed conditions or provisions in the SELLER's Bid Forms or acknowledgment of CONTRACT, invoices, packing list and other documents which purport to impose any conditions at variance with or be supplemental to CONTRACT.

9.0 **Patent Rights, Liability & Compliance of Regulations:**

- 9.1 SELLER hereby warrants that the use or sale of the materials delivered hereunder will not infringe claims of any patent covering such material and SELLER agrees to be responsible for and to defend at his sole expense all suits and proceedings against PURCHASER based on any such alleged patent infringement and to pay all costs, expenses and damages which PURCHASER and/or CONSULTANT may have to pay or incur by reason of any such suit or proceedings.
- 9.2 The SELLER shall indemnify the PURCHASER against all third party claims of infringement of patent, trade mark or industrial design rights arising from use of the GOODS or any part thereof in the PURCHASER's country.
- 9.3 SELLER shall also protect and fully indemnify the PURCHASER from any claims from SELLER's workmen/employees or their heirs, dependants, representatives, etc. or from any other person/persons or bodies/companies etc. for any acts of commissions or omission while executing the CONTRACT.
- 9.4 SELLER shall be responsible for compliance with all requirements under the laws and shall protect and indemnify completely the PURCHASER from any claims/penalties arising out of any infringements.
- 9.5 PURCHASER will promptly notify the SELLER in writing of any such claim, suit, action or proceeding coming to its attention, giving authority and all available information and assistance for the SELLER's defence of the same. If at any time the installation of the plant or any part thereof, or the use thereof in India for the purpose for which it is furnished or the sale of products produced therewith, is prevented or enjoined because of patent infringement or claimed infringement, the SELLER shall promptly at his own expense, either procure for PURCHASER the rights to use and continue to use such plant or replace the same at his own expense with equally efficient non-infringing plant satisfactory under all requirements of the contract, so that the operation of PURCHASER's plant will not be unduly delayed or interrupted. If shipment of the plant, or any part thereof is prevented by attachment, injunction or otherwise, or in the course of transit from the SELLER's factory or other point of origin to the site of PURCHASER, as a result of any claim of patent infringement the SELLER shall, at his own cost and expense, promptly furnish and post the necessary bond or take such other steps as may be necessary to enable shipment to be made without delay. PURCHASER will have the right to retain counsel of its own choice to collaborate in the defence of any such claim, suit action or proceeding.

10.0 **Inspection, Testing & Expediting**

- 10.1 The PURCHASER or its representative shall have the right to inspect and/or to test the GOODS to confirm their conformity to the CONTRACT specifications. The special conditions of CONTRACT and/or the Technical Specifications shall specify what inspections and tests the PURCHASER requires and where they are to be conducted. The PURCHASER shall notify the SELLER in writing the identity of any representative(s) retained for these purposes.
- 10.2 The inspections and tests may be conducted on the premises of the SELLER or his sub-contractor(s), at point of DELIVERY and/or at the GOODS' final destination. When conducted on the premises of the SELLER or his sub-contractor (s), all reasonable facilities and assistance including access to the drawings and production data shall be furnished to the inspectors at no charge to the PURCHASER.
- 10.3 Should any inspected or tested GOODS fail to conform to the specifications, the PURCHASER may reject them and the SELLER shall either replace the rejected GOODS or make all alterations necessary to meet Specifications' requirements, free of cost to the PURCHASER.
- 10.4 The PURCHASER's right to inspect, test and where necessary reject the GOODS after the GOODS' arrival in the PURCHASER's country shall in no way be limited or waived by reason of the GOODS having previously been inspected, tested and passed by the PURCHASER, or their representative prior to the GOODS shipment from the country of origin.
- 10.5 The INSPECTOR shall follow the progress of the manufacture of the GOODS under the CONTRACT to ensure that the requirements outlined in the CONTRACT are not being deviated with respect to schedule and quality.
- 10.6 SELLER shall allow the INSPECTOR to visit, during working hours, the workshops relevant for execution of the CONTRACT during the entire period of CONTRACT validity.
- 10.7 In order to enable PURCHASER's representatives to carryout the inspection in time, SELLER shall notify PURCHASER 15 days before assembly, testing and packing of main EQUIPMENT. If requested, SELLER shall assist PURCHASER's representatives in getting visas in the shortest possible time (applicable only in case of foreign order).
- 10.8 SELLER shall place at the disposal of the INSPECTOR, free of charge, all tools, instruments, and other apparatus necessary for the inspection and/or testing of the GOODS. The INSPECTOR is entitled to prohibit the use and dispatch of GOODS and/or materials which have failed to comply with the characteristics required for the GOODS during tests and inspections.
- 10.9 SELLER shall advise in writing of any delay in the inspection program at the earliest, describing in detail the reasons for delay and the proposed corrective action.
- 10.10 ALL TESTS and trials in general, including those to be carried out for materials not manufactured by SELLER shall be witnessed by the INSPECTOR. Therefore, SELLER shall confirm to PURCHASER by fax or e-mail about the exact date of inspection with at least 30 days notice. SELLER shall specify the GOODS and quantities ready for testing and indicate whether a preliminary or final test is to be carried out.

- 10.11 If on receipt of this notice, should PURCHASER waive the right to witness the test, timely information will be given accordingly.
- 10.12 Any and all expenses incurred in connection with tests, preparation of reports and analysis made by qualified laboratories, necessary technical documents, testing documents and drawings shall be at SELLER's cost. The technical documents shall include the reference and numbers of the standards used in the construction and, wherever deemed practical by the INSPECTOR, copy of such standards.
- 10.13 Nothing in Article-10 shall in any way release the SELLER from any warranty or other obligations under this CONTRACT.
- 10.14 Arrangements for all inspections required by Indian Statutory Authorities and as specified in technical specifications shall be made by SELLER.
- 10.15 **Inspection & Rejection of Materials by consignees:**
When materials are rejected by the consignee, the supplier shall be intimated with the details of such rejected materials, as well as the reasons for their rejection, also giving location where such materials are lying at the risk and cost of the supplier. The supplier will be called upon either to remove the materials or to give instructions as to their disposal within 14 days and in the case of dangerous, infected and perishable materials within 48 hours, failing which the consignee will either return the materials to the SELLER freight to pay or otherwise dispose them off at the SELLER's risk and cost. The PURCHASER shall also be entitled to recover handling and storage charges for the period, during which the rejected materials are not removed @ 5% of the value of materials for each month or part of a month till the rejected materials are finally disposed off.
- 11.0 **Time Schedule & Progress Reporting**
- 11.1 Together with the Contract confirmation, SELLER shall submit to PURCHASER, his time schedule regarding the documentation, manufacture, testing, supply, erection and commissioning of the GOODS.
- 11.2 PURCHASER's/CONSULTANT's representatives shall have the right to inspect SELLER's premises with a view to evaluating the actual progress of work on the basis of SELLER's time schedule documentation.
- 11.3 Irrespective of such inspection, SELLER shall advise PURCHASER at the earliest possible date of any anticipated delay in the progress.
- 11.4 Notwithstanding the above, in case progress on the execution of contract at various stages is not as per phased time schedule and is not satisfactory in the opinion of the PURCHASER/CONSULTANT which shall be conclusive or SELLER shall neglect to execute the CONTRACT with due diligence and expedition or shall contravene the provisions of the CONTRACT, PURCHASER/CONSULTANT may give notice of the same in writing to the SELLER calling upon him to make good the failure, neglect or contravention complained of. Should SELLER fail to comply with such notice within the period considered reasonable by PURCHASER/CONSULTANT, the PURCHASER/CONSULTANT shall have the option and be at liberty to take the CONTRACT wholly or in part out of the SELLER's hand and make alternative arrangements to obtain the requirements and completion of CONTRACT at the SELLER's risk and cost and recover from the SELLER, all extra cost incurred by the PURCHASER on this account. In such event, PURCHASER/CONSULTANT shall not be responsible for any loss that the SELLER may incur, and SELLER shall not be entitled to any gain. PURCHASER/CONSULTANT shall, in addition, have the right to encash Performance Guarantee in full or part.
- 12.0 **Delivery & Documents:**
- 12.1 Delivery of the GOODS shall be made by the SELLER in accordance with terms specified in the CONTRACT, and the goods shall remain at the risk of the SELLER until delivery has been completed.
- 12.2 Delivery shall be deemed to have been made:
a) In the case of FOB, CFR & CIF Contracts, when the Goods have been put on board the ship, at the specified port of loading and a clean Bill of Lading is obtained. The date of Bill of Lading shall be considered as the delivery date.
b) In case of FOT despatch point contract (For Indian bidder), on evidence that the goods have been loaded on the carrier and a negotiable copy of the GOODS receipt obtained, the date of LR/GR shall be considered as the date of delivery. c) In case of FOT site/ FOR Destination (for Indian bidders), on receipt of goods by PURCHASER/Consultant at the designated site(s).
- 12.3 The delivery terms are binding and essential and consequently, no delay is allowed without the written approval of PURCHASER/CONSULTANT. Any request concerning delay will be void unless accepted by PURCHASER/CONSULTANT through a modification to the CONTRACT.
- 12.4 Delivery time shall include time for submission of drawings for approval, incorporation of comments, if any, and final approval of drawings by PURCHASER/CONSULTANT
- 12.5 In the event of delay in delivery, Liquidated Damages as stipulated in Article - 22.1 shall apply.
- 12.6 The documentation, in English Language, shall be delivered in due time, in proper form and in the required number of copies as specified in the contract.
- 12.7 The additional copies of final drawings and instructions will be included in the package of goods, properly enveloped and protected.
- 12.8 The SELLER should comply with the Packing, Marking and Shipping Documentation Specifications enclosed.
- 13.0 **Transit Risk Insurance**
- 13.1 All goods supplied under the contract shall be fully insured in a freely convertible currency against loss or damage incidental to manufacture or acquisition, transportation, storage and delivery.
- 13.2 Where delivery is on FOB or CFR basis, marine insurance shall be the responsibility of the Purchaser. Insurance Requirements > Indigenous Bidders: Transit risk insurance from F.O.T. despatch point onwards shall be arranged and borne by PURCHASER. In case of F.O.T site contracts, transit insurance to be borne by SELLER. > Foreign Bidders: Marine insurance as well as transit insurance in Purchaser's country shall be arranged and borne by PURCHASER. The SELLER shall ensure that in effecting despatch of materials, the primary responsibility of the carriers for safe movement is always retained so that the PURCHASER's interests are fully safeguarded and are in no way jeopardised. The Seller shall furnish the cost of materials against each equipment.
- 14.0 **Transportation**
- 14.1 Where the SELLER is required under the CONTRACT to deliver the GOODS FOB, transport of the GOODS until delivery, that is, upto and including the point of putting the GOODS on board the export conveyance at the specified port of loading, shall be arranged and paid for by the SELLER and the cost thereof shall be included in the Contract price.
- 14.2 Where the SELLER is required under the CONTRACT to deliver the GOODS CFR or CIF, transport of the Goods to the port of discharge or such other point in the country of destination as shall be specified in the CONTRACT shall be arranged and paid for by the SELLER and the cost thereof shall be included in the Contract price.
- 15.0 **Incidental Services:**
- 15.1 The Seller may be required to provide any or all of the following services:
- 15.1.1 Performance or supervision of onsite assembly and/or start-up of the supplied Goods:
- 15.1.2 Furnishing tools required for assembly and/or maintenance of the supplied Goods:
- 15.1.3 Performance or supervision or maintenance and/or repair of the supplied Goods, for a period of time agreed by the parties, provided that this service shall not relieve the Seller of any warranty/ guarantee obligations under the Contract.
- 15.1.4 Training of the Purchaser's personnel at the Seller's plant and/or at Site, in assembly, start-up operation, maintenance and/or repair of the supplied Goods at no extra cost. However, Purchaser will bear boarding, lodging & personal expenses of Trainees.
- 15.2 Prices charged by the Seller for the preceding incidental services, shall not exceed the prevailing rates charged to other parties by the Seller for similar services.
- 15.3 When required, Seller shall depute necessary personnel for supervision and/or erection of the Equipment at site for duration to be specified by Purchaser on mutually agreed terms. Seller's personnel shall be available at Site within seven days for emergency action and twenty one days for medium and long-term assistance, from the date of notice given by Purchaser.
- 15.4 The cost of incidental services shall not be included in the quoted prices. The cost of applicable incidental services should be shown separately in the price schedules whenever asked for in the tender.
- 16.0 **Spare Parts, Maintenance Tools, Lubricants**
- 16.1 Seller may be required to provide any or all of the following materials and notification pertaining to spare parts manufactured or distributed by the Seller.
- 16.1.1 Such spare parts as the Purchaser may opt to purchase from the Seller, provided that his option shall not relieve the Seller of any warranty obligations under the Contract, and 16.1.2 In the event of termination of production of the spare parts:
i) Advance notification to the Purchaser of the pending termination, in sufficient time to permit the Purchaser to procure needed requirements, and
ii) Following such termination, furnishing at no cost to the Purchaser, the blueprints, drawings and specifications of the spare parts, if any when, requested.

- 16.2 Seller shall supply item wise list with value of each item of spare parts and maintenance tools requirements, along with full details of manufacturers/vendors for such spares/maintenance tools for:
- 16.2.1 The construction, execution and commissioning.
- 16.2.2 Two years operation and maintenance.
- 16.3 Spare parts shall be new and of first-class quality as per engineering standards/ codes, free of any defects (even concealed), deficiency in design, materials and workmanship and also shall be completely interchangeable with the corresponding parts.
- 16.4 Type and sizes of bearings shall be clearly indicated.
- 16.5 Spare parts shall be packed for long storage under tropical climatic conditions in suitable cases, clearly marked as to intended purpose.
- 16.6 A list of special tools and gauges required for normal maintenance and special handling and lifting appliances, if any, for the Goods shall be submitted to Purchaser.
- 16.7 Bidders should note that if they do not comply with Clause 16.2 above, their quotation may be rejected.
- 16.8 **Lubricants**
- 16.8.1 Whenever lubricants are required, Seller shall indicate the quantity of lubricants required for the first filling, the frequency of changing, the quantity of lubricants required for the one year's continuous operation and the types of recommended lubricants indicating the commercial name (trade-mark), quality and grade.
- 16.8.2 If Seller is unable to recommend specific oil, basic recommended characteristics of the lubricants shall be given.
- 16.8.3 Seller shall indicate various equivalent lubricants available in India.
- 17.0 **Guarantee**
- 17.1 All Goods or Materials shall be supplied strictly in accordance with the specifications, drawings, data sheets, other attachments and conditions stated in the Contract. No deviation from such specifications or alterations or of these conditions shall be made without PURCHASER'S /CONSULTANT'S agreement in writing which must be obtained before any work against the order is commenced. All materials supplied by the SELLER pursuant to the Contract (irrespective of whether engineering, design data or other information has been furnished, reviewed or approved by PURCHASER) are guaranteed to be of the best quality of their respective kinds (unless otherwise specifically authorised in writing by PURCHASER) and shall be free from faulty design, workmanship and materials, and to be of sufficient size and capacity and of proper materials so as to fulfil in all respects all operating conditions, if any, specified in the Contract.
- If any trouble or defect, originating with the design, material, workmanship or operating characteristics of any materials, arises at any time prior to twelve(12) months from the date of the first commercial operation of the Plant for which the materials supplied under the Contract form a part thereof, or Fifteen (15) months from the date of last shipment whichever period shall first expire, and the SELLER is notified thereof, SELLER shall, at his own expense and as promptly as possible, make such alterations, repairs and replacements as may be necessary to permit the materials to function in accordance with the specifications and to fulfil the foregoing guarantees. PURCHASER may, at his option, remove such defective materials, at SELLER'S expense in which event SELLER shall, without cost to PURCHASER and as promptly as possible, furnish and install proper materials. Repaired or replaced materials shall be similarly guaranteed by the SELLER for a period of no less than twelve (12) months from the date of replacement/repair.
- In the event that the materials supplied do not meet the specifications and/or not in accordance with the drawings, data sheets or the terms of the Contract and rectification is required at site, PURCHASER shall notify the SELLER giving full details of differences. The SELLER shall attend the site within seven (7) days of receipt of such notice to meet and agree with representatives of PURCHASER, for taking the action required to correct the deficiency. Should the SELLER fail to attend meeting at Site within the time specified above, PURCHASER shall immediately rectify the work/ materials and SELLER shall reimburse PURCHASER all costs and expenses incurred in connection with such trouble or defect.
- 17.2 **PERFORMANCE GUARANTEE OF EQUIPMENT**
- 17.2.1 SELLER shall guarantee that the performance of the EQUIPMENT supplied under the CONTRACT shall be strictly in conformity with the specifications and shall perform the functions specified under the CONTRACT.
- 17.2.2 If the SELLER fails to prove the guaranteed performance of the EQUIPMENT set forth in the specification, the SELLER shall investigate the causes and carry out necessary rectifications/modifications to achieve the guaranteed performance. In case the SELLER fails to do so within a reasonable period, the SELLER shall replace the EQUIPMENT and prove guaranteed performance of the new equipment without any extra cost to PURCHASER.
- 17.2.3 If the SELLER fails to prove the guarantee within a reasonable period, PURCHASER/CONSULTANT shall have the option to take over the EQUIPMENT and rectify, if possible, the EQUIPMENT to fulfil the guarantees and/or to make necessary additions to make up the deficiency at Seller's risk and cost. All expenditure incurred by the PURCHASER/ CONSULTANT in this regard shall be to SELLER'S account.
- 18.0 **Prices:**
- Prices charged by the SELLER for Goods delivered and services performed under the CONTRACT shall not, with the exception of any price adjustments authorized by the Contract vary from the prices quoted by the SELLER in his bid. The price indicated in the Purchase Order is firm and not subject to alteration on any account unless specified otherwise in the terms and conditions of Purchase Order. However, in case of delayed delivery, price reduction clause shall apply.
- 19.0 **Subletting and Assignment:**
- The SELLER shall not without previous consent in writing of the PURCHASER, sublet, transfer or assign the contract or any part thereof or interest therein or benefit or advantage thereof in any manner whatsoever. Provided, nevertheless, that any such consent shall not relieve the SELLER from any obligation, duty or responsibility under the contract.
- 20.0 **Time as Essence of Contract:**
- The time and date of delivery/completion of the GOODS/SERVICES as stipulated in the Contract shall be deemed to be the essence of the Contract.
- 21.0 **Delays in The Seller's Performance:**
- If the specified delivery schedule is not adhered to or the progress of manufacture or supply of the items is not satisfactory or is not in accordance with the progress schedule, the PURCHASER has the right to:
- i) hire for period of delay from elsewhere goods which in PURCHASER'S opinion will meet the same purpose as the goods which are delayed and SELLER shall be liable without limitation for the hire charges;
- Or
- ii) cancel the CONTRACT in whole or in part without liability for cancellation charges. In that event, PURCHASER may procure from elsewhere goods which PURCHASER'S opinion would meet the same purpose as the goods for which CONTRACT is cancelled and SELLER shall be liable without limitations for the difference between the cost of such substitution and the price set forth in the CONTRACT for the goods involved; or iii) hire the substitute goods vide (i) above and if the ordered goods continue to remain undelivered thereafter, cancel the order in part or in full vide (ii) above.
- 21.1 Any un-excusable delay by the SELLER or his subcontractor shall render the SELLER liable, without prejudice to any other terms of the Contract, to any or all of the following sanctions: forfeiture of Contract performance guarantee, imposition of Liquidated Damages for delay in delivery, termination of the contract for default and purchase from another source at the risk and cost of the SELLER.
- 22.1 **Liquidated Damages Schedule for Delayed Delivery** Subject to Article -25, if the SELLER fails to deliver any or all of the GOODS or performance the services within the time period (s) specified in the CONTRACT, the PURCHASER shall, without prejudice to his other remedies under the CONTRACT, deduct from the CONTRACT PRICE, a sum calculated on the basis of the CONTRACT PRICE, including subsequent modifications.
- 22.1.1 **Deductions shall apply as per following formula:**
- A sum equivalent to 0.5 (Half) per cent of the prices of any portion of stores delivered late, for each week or part thereof of delay. The total damages shall not exceed 10 (Ten) percent of the value of delayed goods. The LD cannot exceed the amount stipulated in the contract.
- 22.2 In case of delay in delivery on the part of SELLER, the invoice/document value shall be reduced proportionately for the delay and payment shall be released accordingly.
- 22.3 In the event the invoice value is not reduced proportionately for the delay, the PURCHASER may deduct the amount so payable by SELLER, from any amount falling due to the SELLER or by recovery against the Performance Guarantee. Both seller and PURCHASER agree that the above percentages of price reduction are

genuine pre estimates of the loss/damage which the PURCHASER would have suffered on account of delay/breach on the part of the SELLER and the said amount will be payable on demand without there being any proof of the actual loss/or damage caused by such breach/delay. A decision of the PURCHASER in the matter of applicability of price reduction shall be final and binding.

23.0 **Rejections, Removal of Rejected Equipment & Replacement**

23.1 Preliminary inspection at SELLER's works by INSPECTOR shall not prejudice PURCHASER's/ CONSULTANT's claim for rejection of the EQUIPMENT on final inspection at SITE or claims under warranty provisions.

23.2 If the EQUIPMENTS are not of specification or fail to perform specified functions or are otherwise not satisfactory the PURCHASER/CONSULTANT shall be entitled to reject the EQUIPMENT/MATERIAL or part thereof and ask free replacement within reasonable time failing which obtain his requirements from elsewhere at SELLER's cost and risk.

23.3 Nothing in this clause shall be deemed to deprive the PURCHASER AND/OR AFFECT ANY rights under the Contract which it may otherwise have in respect of such defects or deficiencies or in any way relieve the SELLER of his obligations under the Contract.

23.4 EQUIPMENT rejected by the PURCHASER/ CONSULTANT shall be removed by the Seller at his cost within 14 days of notice after repaying the amounts received against the SUPPLY. The PURCHASER shall in no way be responsible for any deterioration or damage to the EQUIPMENT under any circumstances whatsoever.

23.5 In case of rejection of EQUIPMENT, PURCHASER shall have the right to recover the amounts, if any, from any of CONTRACTOR'S invoices pending with PURCHASER or by alternative method(s).

24.1 **Termination for Default**

24.1.1 In the event that the SELLER commits a breach of the provisions of this CONTRACT and/or fails to perform any of its obligations under this CONTRACT including but not limited to failing to deliver any or all of the GOODS within the time period (s) specified in the CONTRACT, the SELLER shall be said to have committed a default of the provisions of this CONTRACT. In the event that such default is not cured by the SELLER within 30 days of a notice issued by the PURCHASER of such default, the PURCHASER shall be entitled to terminate this CONTRACT forthwith. The PURCHASER may, at its sole discretion, extend the time for curing the default by the SELLER beyond 30 days. The PURCHASER may, without prejudice to any other remedy for breach of CONTRACT, by written notice of default sent to the SELLER, terminate the CONTRACT in whole or in part:

A) If the SELLER fails to deliver any or all of the GOODS within the time period(s) specified in the CONTRACT; or

B) If the SELLER fails to perform any other obligation(s) under the CONTRACT, and

C) If the SELLER, in either of the above circumstances, does not cure his failure within a period of 30 days (or such longer period as the PURCHASER may authorize in writing) after receipt of the default notice from the PURCHASER

24.1.2 In the event the PURCHASER terminates the CONTRACT in whole or in part, pursuant to Article 24.1.1 the PURCHASER may procure, upon such terms and in such manner as it deems appropriate, goods similar to those undelivered and the SELLER shall be liable to the PURCHASER for any excess costs for such similar GOODS. However, the SELLER shall continue performance of the CONTRACT to the extent not terminated.

24.1.3 In case of termination of CONTRACT herein set forth (under clause 24) except under conditions of Force Majeure and termination after expiry of contract, the VENDOR shall be blacklisted/ Debarred as per prevailing guidelines.

24.2 **Termination for Insolvency**

24.2.1 The PURCHASER, may at any time, terminate the CONTRACT by giving written notice to the SELLER, without compensation to the SELLER, if the SELLER becomes bankrupt or otherwise insolvent, provided that such termination will not prejudice or affect any right of action or remedy which has accrued or will accrue thereafter to the PURCHASER.

25.0 **Force Majeure**

25.1 Force majeure is an event beyond the control of SELLER and not involving the SELLER's fault or negligence and which is not foreseeable, which prevents the SELLER from fulfilling its obligations under the CONTRACT. Force Majeure shall mean and be limited to the following:

a) War/hostilities

b) Riot or Civil commotion

c) Earthquake, flood, tempest, lightning or other natural physical disaster.

d) Restrictions imposed by the Government or other Statutory bodies which prevent or delay the execution of the Contract by the SELLER.

The decision as to whether an event constitutes force majeure shall rest with PURCHASER which shall be final and binding.

25.2 If there is delay in performance or other failures by the SELLER to perform obligations under the contract due to event of a Force Majeure, the SELLER shall not be held responsible for such delays/failures.

25.3 If a Force Majeure situation arises, the SELLER shall promptly notify the purchaser in writing of such conditions and the cause thereof within fifteen days of occurrence of such event. Unless otherwise directed by the Purchaser in writing, the SELLER shall continue to perform its obligations under the contract as far as reasonable/practical and shall seek all reasonable alternative means for performance not prevented by the Force Majeure event.

25.4 If the performance in whole or in part or any obligation under this contract is prevented or delayed by any reason of Force Majeure for a period of exceeding 120 days, PURCHASER may at its option terminate the contract without any financial repercussion on either side.

26.0 **Resolution of Disputes/ Arbitration:**

26.1 The PURCHASER and the SELLER shall make every effort to resolve amicably by direct informal, good faith negotiations any disagreement or dispute arising between them under or in connection with the contract.

26.2 If, after thirty days from the commencement of such informal negotiations, the PURCHASER and the SELLER have been unable to resolve the disagreement or dispute, the same be referred for resolution to the formal mechanism as specified hereunder.

26.3 Legal Construction: The Contract shall in all respects be construed and operated as an Indian Contract and in accordance with Indian Laws as in force for the time being.

26.4 **Arbitration:**

a) All disputes and differences of any kind whatsoever arising out of or in connection with the contract or carrying out of the works (whether during the course of works or after their completion and whether before or after termination, abandonment or breach of contract) shall be referred to and settled by the person authorized and notified in writing by PURCHASER who shall state his decision in writing. Such a decision may be in the form of a final certificate or otherwise and shall be made within a period of 30 days from the date of receipt of such reference to them.

b) If the SELLER is dissatisfied with the decision of such authorized person, then he may within 30 days of receipt of such decision send a written appeal to PURCHASER, represented by the Chairman and Managing Director at the registered office, Mumbai for the same to be referred to Arbitration by a Sole Arbitrator to be appointed by mutual consent and after due approval of CMD, IREL. The Arbitration proceedings shall be conducted as per the provisions of the Arbitration and Conciliation Act, 1996. It is made clear that this Arbitration Clause shall be applicable to any and all disputes and differences between the Parties arising out of and/or relating to this CONTRACT and the Parties shall be bound to refer the same to arbitration in accordance with the procedure contemplated herein

c) If the period of 30 days under Clause (b) has expired at any stage, stipulated in the preceding paras without any response from the SELLER before such expiry, the SELLER is deemed to have communicated his satisfaction to the decision of PURCHASER at the relevant stage and all his rights of further appeal or as the case may be and adjudication are deemed to have been waived once and for all.

d) The seat of arbitration will be at Mumbai and language thereof shall be English.

e) Notwithstanding the invocation, commencement and/or pendency any dispute resolution proceedings under this Clause 26.0 including arbitration under Clause 26.4, the SELLER shall continue to be bound by the provisions of the CONTRACT, if not terminated by the EMPLOYER, and shall be obligated to discharge its obligations under the CONTRACT including continuation of the WORK under the CONTRACT.

f) The Bidder shall not in any way delay or default or cause to delay or default the carrying out of the works by reason of the fact that any matter has been agreed to be referred for dispute resolution under Clause 26.0 including Arbitration under Clause 26.4.

26.5 Jurisdiction The courts at Kochi only shall, subject to Arbitration Clause, have exclusive jurisdiction to deal with and decide any matter arising out of this contract.

27. **Taxes & Duties**
- 27.1 A foreign Seller shall be entirely responsible for all taxes, stamp duties, licence fees, and other such levies imposed outside the PURCHASER's country.
- 27.2 A domestic Seller shall be entirely responsible for all taxes, duties, licence fees etc. incurred until the delivery of the contracted goods to the PURCHASER. However, GST on finished products shall be reimbursed by PURCHASER. Seller need to prepare E-Invoice under GST and submit monthly / quarterly GST Return as per GST Rules. Failure to submit GST Return on time as per GST Rules may result into deduction of GST while processing suppliers' Bill.
- 27.3 Customs duty payable in India for imported goods ordered by PURCHASER on foreign Seller shall be borne and paid by PURCHASER.
- 27.4 Any income tax payable in respect of supervisory services rendered by foreign Seller under the Contract shall be as per the Indian Income Tax Act and shall be borne by SELLER. It is upto the bidder/seller to ascertain the amount of these taxes and to include them in his bid price.
28. **Permits & Certificates**
- 28.1 SELLER shall procure, at his expense, all necessary permits, certificates and licences required by virtue of all applicable laws, regulations, ordinances and other rules in effect at the place where any of the work is to be performed, and SELLER further agrees to hold PURCHASER and/or CONSULTANT harmless from liability or penalty which might be imposed by reason of any asserted or established violation of such laws, regulations, ordinances or other rules. PURCHASER will provide necessary permits for SELLER's personnel to undertake any work in India in connection with Contract.
29. **Fall Clause**
- 29.1 The price charged for the materials supplied under the order by the supplier shall in no event exceed the lowest price at which the supplier or his agent/principal/dealer, as the case may be, sells the materials of identical description to any Persons/Organizations including the Purchaser or any Department of the Central Govt. or any Department of a State Govt. or any Statutory Undertaking of the Central or State Govt. as the case may be, during the currency of the order.
- 29.2 If at any time during the said period, the supplier or his agent/principal/dealer, as the case may be, reduces the sale price, sells or offers to sell such materials to any persons/organizations including the Purchaser or any Deptt. Of Central Govt. or State Govt. as the case may be, at a price lower than the price chargeable under the order, he shall forthwith notify such reduction or sale or offer of sale to the Purchase Authority who has issued this order and the price payable under the order for the materials supplied after the date of coming into force of such reduction or sale or offer of sale shall stand correspondingly reduced. The above stipulation will, however, not apply to:
- a) Exports by the Contractor/Supplier or
- b) Sale of goods as original equipment at prices lower than the prices charged for normal replacement
- c) Sale of goods such as drugs which have expiry dates.
- 29.3 The supplier shall furnish the following certificate to the concerned Paying Authority along with each bill for payment for supplies made against this order:- "I/We certify that there has been no reduction in sale price of the items/goods/materials of description identical to those supplied to the PURCHASER under the order herein and such items/goods/materials have not been offered/sold by me/us to any person/organizations including the Purchaser or any Deptt. of Central Govt. or any Deptt. of State Govt. or any Statutory Undertaking of the Central or State Govt. as the case may be upto the date of bill/during the currency of the order whichever is later, at a price lower than the price charged to the PURCHASER under the order". Such a certificate shall be obtained, except for quantity of items/goods/materials categories under sub-clause (a), (b) & (c) of sub-para 29.2 above, of which details shall be furnished by the supplier.
- 30.0 **Limitation of Liability**
- Notwithstanding anything contrary contained herein, the aggregate total liability of Seller under the Agreement or otherwise shall be limited to 100% of Agreement / Order price. However, neither party shall be liable to the other party for any indirect and consequential damages, loss of profits or loss of production.
- 31.0 **Method of blacklisting vendors**
- 31.1 Any failure by the vendor (SELLER) to supply/execute the contract as per order may result in blacklisting of vendors by the PURCHASER through its competent authority. The blacklisted vendor shall not be considered for a minimum period of one year from the date of blacklisting.
- 31.2 Further the competent authority may blacklist the bidder, if the bidder changes bid (either techno-commercial and / or price) or withdraw his bid after receipt of the same and during the validity period of bid.
- 31.3 Further, the vendor (SELLER) shall be banned from doing any business with the PURCHASER, indefinitely or for such period as may be determined by the PURCHASER at its sole discretion, in case of :
- a. If security considerations including question of loyalty to the state so warrant.
- b. If the proprietor, partner, Director's representative of the SELLER is convicted by a court of law following prosecution for any offences including offences relating to business or commercial dealings.
- c. If there is strong justification, as determined by the PURCHASER at its sole discretion, for believing that the proprietor or employee or representative of the SELLER has been guilty of malpractice such as bribery, corruption, fraud, substitution of tenders, interpolation, misrepresentation, evasion or habitual default in payment of any tax levied by law, etc.
- 31.4 An order for ban/ suspension passed for a certain specified period shall be deemed to have been automatically revoked on expiry of that specified period and it will not be necessary to issue a specific formal order of revocation, except that an order of suspension/ban passed on account of doubtful loyalty or security consideration shall continue to remain in force until it is specifically revoked in writing.
- 31.5 An order of ban on grounds of conviction by Court of Law may be revoked if, in respect of the same facts, the SELLER has been wholly acquitted by a court of law.
- 32.0 **Secrecy**
- The SELLER shall not at any time during the pendency of the contract or thereafter disclose any information furnished to them by PURCHASER or any drawings, designs, reports and other documents and information prepared by the Contractor for this contract, without the prior written approval of PURCHASER except in so far as such disclosure is necessary for the performance of the Contractor's work and service hereunder.
33. **General**
- 33.1 In the event that terms and conditions stipulated in the General Conditions of Contract should deviate from terms and conditions stipulated in the Contract, the latter shall prevail. Any specific Terms / Conditions mentioned in PO will supersede this GCC.
- 33.2 Losses due to non-compliance of Instructions: Losses or damages occurring to the PURCHASER owing to the SELLER's failure to adhere to any of the instructions given by the PURCHASER/CONSULTANT in connection with the contract execution shall be recoverable from the SELLER.
- 33.3 Recovery of sums due: All costs, damages or expenses which the PURCHASER/CONSULTANT may have paid, for which under the contract, SELLER is liable, may be recovered by the PURCHASER (he is hereby irrevocably authorized to do so) from any money due to or becoming due to the SELLER under this Contract or other Contracts and/or may be recovered by action at law or otherwise. If the same due to the SELLER be not sufficient to recover the recoverable amount, the SELLER shall pay to the PURCHASER, on demand, the balance amount.
- 33.4 Payments, etc. not to affect rights of the PURCHASER: No sum paid on account by the PURCHASER nor any extension of the date for completion granted by the PURCHASER shall affect or prejudice the rights of the PURCHASER against the SELLER or relieve the SELLER of his obligation for the due fulfillment of the CONTRACT.
- 33.5 Cut-off Dates : No claims or correspondence on this Contract shall be entertained by the PURCHASER/Consultant after 90 days after expiry of the performance guarantee (from the date of final extension, if any).
- 33.6 Paragraph heading: The paragraph heading in these conditions shall not affect the construction thereof
- 34.0 **RISK PURCHASE CLAUSE**
- After award of the contract, if the tenderer fails to execute the work as per tender or at any time repudiates the order, IREL (India) Limited has the right to forfeit and invoke the security deposit and execute the order from other agencies at the risk and cost of the tenderer. The cost difference between the alternative arrangements and total contract value will be recovered from the tenderer along with other incidental charges. In case of execution of order through alternative sources and if price is lower, no benefit on this account will be passed on to the tenderer.

Annexure-X

Signature and seal of the contractor

Page 32 of 37

PROFORMA FOR BANK GUARANTEE FOR EARNEST MONEY DEPOSIT

In accordance with Notice Inviting Tender (NIT) No. _____ Dated _____ for the work of _____ (herein after referred to as "the said Works") for Rs. _____ (Rupees _____ only), under RED unit of M/s IREL (India) Limited, a company incorporated under Indian Companies Act, having its registered office at Plot No.1207, ECIL building, Opp. to Siddhivinayak Temple, Veer Savarkar Marg, Prabhadevi, Mumbai - 400028, India (herein after referred to as IREL), M/s _____ Address _____ [Herein after referred to as Contractor (s)] wish / wishes to participate in the said tender and a Bank Guarantee for the sum of Rs. _____ (in words) valid for a period of _____ days (in words) is required to be submitted by the Bidder towards the Bid Security.

We the _____ Bank (hereinafter called the said Bank) do hereby undertake to pay to IREL, the sum of Rs. _____ (Rupees _____ only) by reason of the said tenderer's failure to enter into an agreement of contract on intimation of acceptance of his tender and/or to commence the contract works and/or failure to deposit the security deposit within the stipulated period as per the terms and conditions relating to and/or governing the contract and/or specified in the Notice Inviting Tender (NIT). We also agree that any such demand made on the Bank shall be conclusive as regards the amount due and payable by the Bank under this Guarantee. We also agree that notwithstanding any dispute or difference or any litigation in respect of or arising from the said contract and/or the acceptance of the tender of the tenderer afore stated by IREL including the question as to the tenability of the claim of the IREL for forfeiting the Earnest Money being the Bank Guarantee herein, we shall forthwith pay the said amount to IREL on demand being made as aforesaid.

We _____ Bank further agree that the guarantee herein contained shall remain in full force and effect during the period that would be taken for entering into an Agreement of contract and that it shall continue to be enforceable till all the dues of the IREL under the terms and conditions of the NIT for the work have been fully paid and its claims satisfied or discharged or till IREL certifies, that the terms and conditions of the NIT have been fully and properly carried out by the said tenderer and accordingly discharges the guarantee.

We _____ Bank further agree with the IREL that the IREL shall have the fullest liberty without our consent and without affecting in any manner our obligations hereunder to vary any of the terms and conditions of the NIT and/or terms and conditions governing the contract or to extend the time of validity of the offer from the said tenderer from time to time or to postpone for any time or from time to any of the powers exercisable by the IREL against the said tenderer and to forbear or enforce any of the terms and conditions of the NIT and we shall not be relieved from our liability hereunder by reason of any such variation, or extension being granted to the said tenderer or for any forbearance, act or omission on the part of the IREL or any indulgence by the IREL to the said tenderer or by any such matter or thing whatsoever which under the law relating to surety/guarantee would but for this provision have effect of so relieving us.

We _____ Bank do hereby further agree that any change in the Constitution of the said tenderer or the Bank will not affect the validity of this guarantee.

We _____ Bank lastly undertake not to revoke this guarantee during its currency except with the previous consent of the IREL in writing.

Notwithstanding anything to the contrary contained herein before:

- (i) Our Liability under this Bank Guarantee shall not exceed and restricted to Rs..... (in words)
- (ii) (ii) This Bank Guarantee shall be valid up to, unless extended on demand.
- (iii) (iii) The bank is liable to pay the guaranteed amount or any part thereof under this bank Guarantee only if IREL serve a written claim or demand on or before (Three months from the expiry of Guarantee period)

Dated the _____ day of _____ 20—

_____ Bank

(Signature with name in Block letters with designation,

Attorney as per power of Attorney No. ____ dt. ____)

Bank's Common seal

Annexure-XI

MANDATE FORM

ELECTRONIC CLEARING SERVICE (DIRECT CLEARING)/REAL TIME GROSS SETTLEMENT (RTGS) FACILITY FOR RECEIVING PAYMENT

A DETAILS OF ACCOUNT HOLDER:-

NAME OF ACCOUNT HOLDER	
COMPLETE CONTACT ADDRESS	
TELEPHONE NUMBER/FAX/E-MAIL	

BANK ACCOUNT DETAILS:-

BANK NAME	
BRANCH NAME WITH COMPLETE ADDRESS, TELEPHONE NUMBER AND E-MAIL	
WHETHER THE BRANCH IS COMPUTRISED	
WHETHER THE BRANCH IS RTGS ENABLED? THEN WHAT IS THE BRANCH IFSC CODE	
TYPE OF BRANCH ALSO NEFT ENABLED?	
TYPE OF BANK ACCOUNT (SB/CURRENT/CASH CREDIT)	
COMPLETE BANK ACCOUNT NUMBER(LATEST)	
MICR CODE OF BANK	

DATE OF EFFECT-

I hereby declare that the particulars given above are correct and complete if the transaction is delayed or not effected at all for reasons of incomplete or incorrect information. I would not hold the user institution responsible. I have read the option invitation letter and agree to discharge responsibility expected of me as a participant under the scheme.

(Signature of Customer)

Certified that the particular furnished above are correct as per correct as per our records (Bank's Stamp)

Date

(Signature of Bank Officer)

Annexure-XII

PROFORMA FOR BANK GUARANTEE FOR SECURITY DEPOSIT

WHEREAS on or about the ____ day of _____ M/s _____ (Tenderer's name & address), having its registered office situated at _____ (Postal address) (herein after referred to as 'The Tenderer') entered into a contract bearing reference no.

_____ dtd. _____ with _____ RED unit of M/s IREL (India) Limited, a company incorporated under Indian Companies Act having its registered office at Plot No.1207, ECIL building, Opp. to Siddhivinayak Temple, Veer Savarkar Marg, Prabhadevi, Mumbai - 400 028, India (herein after referred to as IREL(India) Limited, for _____ (details of order) (herein after referred to as 'The Contract').

AND WHEREAS under the terms and conditions of the contract the tenderer is required to keep with IREL (India) Limited a security deposit of Rs. _____ (Rupeesonly) or submit a Bank Guarantee in lieu of cash deposit for the fulfillment of the terms and conditions of the contract, and whereas the supplier has chosen to submit a Bank Guarantee.

We _____ Bank do hereby undertake to pay the amounts due and payable under this Guarantee without any demur, merely on a demand from IREL (India) Limited stating that the amount claimed is due by way of loss or damage caused to or that would be caused to or suffered by IREL (India) Limited by reason of breach of any of the terms and conditions of the said contract. Any such demand made on the bank shall be conclusive as regards the amount due and payable by the Bank under this Guarantee. The payment will be released within three working days from the date of demand for payment.

We undertake to pay to IREL (India) Limited any money so demanded notwithstanding any dispute or disputes raised by the tenderer in any suit or proceeding pending before any court or tribunal relating thereto, our liability under these present being absolute and unequivocal.

The payment so made by us under this guarantees shall be valid discharge of our liability for payment thereunder and the tenderer shall have no claim against us for making such payment.

We _____ Bank further agree that the Guarantee herein contained shall remain in full force and effect during the period that would be taken for the performance of the said Agreement and that it shall continue to be enforceable till all the dues of IREL (India) Limited under or by virtue of the said Agreement have been fully paid and its claims satisfied or discharged or till IREL (India) Limited certifies that the terms and conditions of the said Agreement have been fully and properly carried out by the said tenderer and accordingly discharges this Guarantee. Our Guarantee shall remain in force until _____ and unless a demand or claim under this guarantee is made on us in writing within three months from the expiry of the Guarantee period, we shall be discharged from all liability under this Guarantee thereafter.

We _____ Bank, further agree that IREL (India) Limited shall have the fullest liberty without our consent and without affecting in any manner our obligations hereunder to vary any of the terms and conditions of the said Agreement or to extent time of performance by the said tenderer from time to time or to

postpone for any time or from time to time any of the powers exercisable by IREL (India) Limited against the said tenderer and to forbear or enforce any of the terms and conditions relating to the said Agreement and we shall not be relived from our liability by reason of any such variation, or extension being granted to the said contract or for any forbearance, act or omission on the part of IREL (India) Limited or any indulgence by IREL(India) Limited to the said tenderer or by any such matter or thing whatsoever which under the law relating to sureties would but for this provision, have effect of so relieving us.

This guarantee will not be discharged due to the change in the constitution of the Bank or the Consultant.

We _____ Bank lastly undertakes not to revoke this guarantee during its currency except with the previous consent of IREL (India) Limited in writing.

Dated the _____ day of _____ 2027

_____ Bank

(Signature with name in Block letters with designation, Attorney as per power of Attorney No. _____ dt. __)

Bank's Common seal